

**OFF-
ROAD
LIVIN'**



can-am®

**2021 ACCESSORIES
EUROPE, MIDDLE EAST AND AFRICA EDITION**

MAVERICK

Quady Śrem - tel. 61 28 35 657 - email: biuro@sklepatv.pl - www.sklepatv.pl

YOUR JOB. OUR ACCESSORIES. LET'S GET IT DONE.

FIT & COMPATIBILITY



FOR US, INNOVATION IS A NO BRAINER. ALL OUR ACCESSORIES WORK TOGETHER, RIGHT OUT OF THE BOX. SO TAKE YOUR PICK. THEN PICK SOME MORE.

STYLE & VISION



WE'VE UPPED THE ANTE ON ACCESSORIES. NOT JUST DESIGNED TO LOOK GOOD, BUT PERFORM RIGHT FOR REAL RIDERS. ALL KILLER, NO FILLER.

QUALITY & RELIABILITY



OUR CAN-AM ACCESSORIES ARE MADE RIGHT THE FIRST TIME. AND TO TOP IT OFF WE THREW IN A 2-YEARS WARRANTY. YOU'RE WELCOME. INSTALL THEM YOURSELF OR AT AN AUTHORIZED DEALER.

can-am

**BRP 2-YEARS
LIMITED WARRANTY**

For new Can-Am accessories, genuine parts, and co-branded products sold through BRP. Includes items installed by you or an authorized BRP dealer.

2021

Quady Śrem - tel. 61 28 35 657 - email: biuro@sklepatv.pl - www.sklepatv.pl

can-am
MAVERICK

ACCESSORIES

Built Inspirations	6
Roofs	11
Soft Cabs	14
Windshield & Mirrors	15
Doors & Rear Wind Protection	19
Skid Plates	22
Bumpers & Guards	23
Seat Accessories	30
LinQ: Easy on, easy off Cargo	31
Cargo & Racks	37
Lights	39
Audio & Communication Systems	45
Electrical & Electronic	48
Winches & Hitches	50
Performance	52
Covers & Add-Ons	58
Apache™ Track Systems	59
Promount Plows	62
Tires & Rims	67

CAN-AMOFFROAD.COM

**EXPERT
CHOICE**

LOOK FOR THIS LOGO THROUGHOUT THE CATALOGUE FOR EXPERT RECOMMENDATIONS ON INNOVATIVE, MUST-HAVE, ENTHUSIAST-READY PARTS AND ACCESSORIES THAT WILL HELP YOU CUSTOMIZE YOUR PERFECT OFF-ROAD MACHINE.

© 2020 Bombardier Recreational Products Inc. (BRP). All rights reserved. ®, TM and the BRP logo are trademarks of BRP or its affiliates. CARLISLE is a trademark of Carlisle Companies. CHAMUDE and HIPORA are registered trademarks of Kolon Industries, Inc. CLARINO is a trademark of Kuraray Co. Ltd. COOLMAX and THERMOLITE are registered trademarks of INVISTA for durable fabrics. DRIRELEASE is a registered trademark of Optimer Inc. FOX is a registered trademark of Fox Racing Canada. GARMIN and MONTANA are registered trademarks of Garmin Ltd. iPod is a registered trademark of Apple Inc. KOLPIN, GUN BOOT and IMPACT are registered trademarks of Kolpin Powersports Inc. KYB is a registered trademark of Kayaba. MicroSD is a registered trademark of SD Card Association. Mud Lite XTR and SS312 are trademarks of ITP Tires. NEXT G-1 VISTA is a trademark of Next Camo, LLC. NGK is a registered trademark of NGK Spark Plugs, Ltd. PRIMALOFT GOLD and PRIMALOFT BLACK are registered trademarks of Albany International Corp. TEFLON, TEFLON HT and KEVLAR are trademarks of E.I. DuPont de Nemours & Co. TWINAIR is a trademark of Twin Air USA. UNI is a trademark of UNIFILTER Inc. VELCRO is a registered trademark of Velcro Industries. WARN is a trademark of Warn Industries Inc. YUASA is a registered trademark of YUASA Batteries Inc. ZILLA and BIGHORN 2.0 are trademarks of Maxxis. SCOTT is a trademark of Scott Sports SA. The following trademarks are the property of their respective owners: BLUETOOTH, CREE, DURO, DWT, HELLA, ITP, KENDA, MOSSY OAK, RAM, SUR LAST, VISION, XPS and YOSHIMURA. DRAGONFIRE is a trademark of KRANSCO. Baja Designs is a registered trademark of Baja Designs Inc. S3 POWERSPORTS is a trademark of S3 Power Sports LLC. Some models depicted herein may include optional equipment. Prices, if shown, are based on Manufacturer Suggested Retail Prices. Dealers may sell for a different price. For Canada and US, taxes are not included. Depending on location, products are distributed by BRP US Inc., Bombardier Recreational Products Inc., BRP European Distribution SA, BRP Finland Oy, BRP Australia Pty Ltd. or BRP Brasil Motorsports LTDA. BRP reserves the right, at any time, to discontinue or change specifications, prices, designs, features, equipment without incurring obligation.

EXPERTLY-CHOSEN PACKAGES

ADD THE ACCESSORIES YOU WANT WITH 3 LEVELS OF UPGRADES:
STARTER, **ADVANCED**, AND **PEAK**. OR MIX AND MATCH OPTIONS—IT'S YOUR RIDE.



DUNE



PERFORMANCE



ADVENTURE



YOU CAN FINANCE THE PURCHASE OF ACCESSORIES
with the purchase and financing of your Maverick. Ask your dealer for all the details.

STARTER

Essential, recommended upgrades
to immediately enhance any
Can-Am vehicle.

ADVANCED

The best all-round, do-anything upgrades
that have proven popular with experienced
riders and new owners alike. Transform
your Can-Am for the years of riding ahead.

PEAK

Limits are for other people:
build your Can-Am Off-Road vehicle
to overcome bigger obstacles &
ride through larger adventures.

KEEP UP WITH SHIFTING LANDSCAPES AND MAXIMIZE YOUR THRILLS: THESE ARE THE PERFECT UPGRADES FOR DUNE & DESERT RIDING.



Quady Śrem - tel. 61 28 35 657 - email: biuro@sklepatv.pl - www.sklepatv.pl

GET THE MOST POPULAR AND EFFECTIVE PERFORMANCE UPGRADES, FOR THRILLS FROM DAY 1 – & EVERY DAY AFTER.



MAVERICK

MAVERICK

STARTER

715002909	Half Windshield	p. 17	1463 zł
715004732	Aluminum Half Doors	p. 20	3642 zł
715002961	Dune Front Bumper	p. 25	1289 zł
715002962	Dune Rear Bumper	p. 25	1289 zł
715004778	LinQ 8 GAL (30 L) Cooler Box	p. 35	1862 zł
715002882	Yoshimura Slip-on Exhaust	p. 55	6024 zł

DUNE

ADVANCED

715002881	LinQ Pivoting Rack	p. 37	2509 zł
715004276	Upper Door Storage Bags	p. 38	625 zł
715003529	Light Support Bar	p. 41	1070 zł
710006821	Baja Designs XL Sport LED Lights	p. 40	2180 zł
710006818	Baja Designs Squadron Sport LED Lights	p. 39	8808 zł
710006819	10" Baja Designs OnX6 LED Light Bar	p. 40	2325 zł

PEAK

715006315	Auxiliary Battery Installation Kit	p. 48	1318 zł
715004900	Audio Roof	p. 46	13 390 zł
715002886	Lighted Whip Flag	p. 48	1417 zł
715002874	Electronic Device Holder	p. 47	746 zł

*Note that price does not include installation requirements and that part numbers may vary depending on vehicle model.

^B Some products shown may not be available or homologated in your country. Contact your BRP dealer for local details.



STARTER

715005510	Lonestar Racing Front Bumper	p. 27	2006 zł
715005512	Lonestar Racing Rear Bumper	p. 27	2156 zł
715005514	Lonestar Racing Rock Sliders	p. 28	1810 zł
715002902	Sport Roof	p. 12	1931 zł
715004694	Front Window Nets	p. 21	792 zł

ADVANCED

715005277	ProVent Windshield	p. 17	4006 zł
715006199	ProVent Roof Module Adapter Kit	p. 12	405 zł
715005279	ProVent Roof Module Kit	p. 12	1018 zł
715006387	Rear Polycarbonate Window	p. 21	1486 zł
715005183	In-Line Triple Yoshimura Slip-On Exhaust	p. 55	7365 zł

PEAK

715002873	Complete MTX Audio system	p. 47	6677 zł
715003734	Lonestar Racing Fire Extinguisher Support	p. 54	919 zł
715004866	Lonestar Racing Heavy-Duty Shift Plate & Knob	p. 52	671 zł
715004865	Lonestar Racing Mud Flaps with Brackets	p. 52	1289 zł

*Note that price does not include installation requirements and that part numbers may vary depending on vehicle model.

Cennik zawiera sugerowane ceny detaliczne brutto w walucie PLN. Ceny mogą ulec zmianie bez wcześniejszego uprzedzenia. Cennik nie jest ofertą w rozumieniu prawa.

ACCESSORIES THAT
TAKE YOU FROM
ZERO TO EXPLORER
IN NO TIME.



MAVERICK MAX

ADVENTURE

STARTER

715003750	Sport Roof MAX	p. 12	3642 zł
715007097	PowerFlip Windshield	p. 16	6712 zł
715003868	Adventure Roof Rack	p. 37	2972 zł
715002973	Fender Flares	p. 26	1561 zł
715006387	Rear Polycarbonate Window	p. 21	1486 zł

ADVANCED

715002903	Front Lower Door Panels	p. 20	1781 zł
715003751	Rear Lower Door Panels	p. 20	1810 zł
715003433	Front Pre-Runner Bumper	p. 24	1810 zł
715003436	Rear Pre-Runner Bumper	p. 24	1810 zł
715003888	Rock Sliders	p. 26	2156 zł
715004007	39" Double Stack LED Light Bar	p. 42	3442 zł
715002873	Complete MTX Audio System	p. 47	6677 zł

PEAK

715003753	Upper Soft Door Panels	p. 21	7515 zł
715003718	HMWPE Skid Plate Protection Kit	p. 22	
715004748	MTX Central Speakers	p. 47	3729 zł
295100698	LinQ 4,2 Gal Cooler	p. 33	1486 zł
715004301	LinQ Tool Box	p. 33	671 zł

*Note that price does not include installation requirements and that part numbers may vary depending on vehicle model.

ROOFS

MADE WITH HIGH-QUALITY MATERIALS DESIGNED IN CONCERT WITH YOUR CAN-AM, OUR ROOFS CREATE A STRONG, LIGHT, RESILIENT BARRIER FROM THE ELEMENTS.



BUILT FOR YOUR VEHICLE

Engineered with the same design, fit, finish, and built-to-last quality found across our lineup.



MAKE IT YOURS

Roof options are the perfect platform for numerous Can-Am accessories that truly transform your Maverick.

100% INTEGRATED

From the power system to speaker mounting, fit and finish, these audio systems were born to rock your Maverick.

Quady Śrem - tel. 61 28 35 657 - email: biuro@sklepatv.pl - www.sklepatv.pl

EXPERT CHOICE

SPORT ROOF

- Impact-resistant injected polypropylene.
- Excellent protection from the elements.
- Provides excellent downhill visibility.
- Windshield compatible.
- Standard on X RS model.

Maverick
 • Easy, tool-less installation and removal with quick-release ¼ turn fasteners and Velcro straps.
715002902 1931 zł

Maverick MAX
 • Easy installation.
715003750 3642 zł



EXPERT CHOICE

PROVENT ROOF MODULE KIT

- Provides fresh air into the cab area.
- Optimal performance with full cab enclosure.
- 4 vents provide infinite adjustment of air flow for driver and passenger.
- Filter and pre-filter to limit dust intrusion.
- Easy cleaning of filter and pre-filter.
- Patent-pending water management system to keep water out of cabin while maintaining air flow.
- Not compatible with roof mounted LED bars, roof racks.
- Outer plug closes air intake completely for winter or heavy weather.
- Requires ProVent Roof Module Adapter Kit (715006199 / 715006371 for MAX), no additional requirement for Can-Am Aluminium Roof.

Maverick, Maverick MAX
715005279 1018 zł



PROVENT ROOF MODULE ADAPTER KIT FOR SPORT ROOF

- (Not illustrated)
- Adapter for fitting ProVent Roof Module Kit onto Maverick Sport Roof.
 - Includes roof adapter and hardware.
 - Requires ProVent Roof Module Kit (715005279).

Maverick 715006199 405 zł **Maverick MAX 715007098 1214 zł**

BIMINI ROOF WITH SUN VISOR

- Heavy-duty canvas made of UV-resistant solution-dyed polyester.
- Innovative soft top comes with a hard visor that allows for storage of rolled-up soft top.
- Easy, tool-less installation and removal with quick-release ¼ turn fasteners and Velcro straps.

Maverick 715002901 1561 zł **715003749 1711 zł**

ALUMINUM ROOF

- Formed aluminum roof 0.09" (2.3 mm) thick.
- Durable and lightweight.
- Sporty look.
- Windshield compatible.
- Easy and tool-less installation.

Maverick 715004224 • Black 2972 zł **715002900 • Silver 2601 zł**



TINTED SUN VISOR

- Tinted polycarbonate construction.
- Extra protection for driver and passenger from the sun.
- Not compatible with Aluminum Roof and Full Windshields.

Maverick, Maverick MAX 715007098 1214 zł



AT LONESTAR RACING, IT'S ALL RACE-ENGINEERED, COMPETITION-PROVEN ACCESSORIES.

GIVE YOUR BEAST MORE BACKBONE



LONESTAR RACING ALUMINUM ROOF

- 0.083" (2.1 mm) thick aluminum roof.
- Durable and lightweight.
- Enhances the vehicle's racing appearance thanks to an authentic sporty look combined with unique graphics.
- Offers you protection from the elements with a personalized touch.

- Includes middle intrusion bars for installation.
- Lower profile than other roofs.
- Compatible with Lonestar Racing Light Bar Racks.
- Not compatible with LinQ Pivoting Rack, Light Support Bar and with Full Windshields.
- "Lonestar Racing for Can-Am" branded.

Includes middle intrusion bars for installation



Hyper Silver / Black Graphics

Maverick produced after January 1, 2017
 ■ 715005508 • Hyper Silver **3885 zł**
 ■ 715005507 • Black **3642 zł**

Maverick MAX
 ■ 715005516 • Hyper Silver **7804 zł**
 ■ 715005515 • Black **7515 zł**



Can-Am Red

Maverick produced after January 1, 2017
 ■ 715004436 • Can-Am Red **3885 zł**

Maverick MAX
 ■ 715004341 • Can-Am Red **7804 zł**

SOFT CABS



↔
Easily remove upper soft door panels when the weather improves!

1. BIMINI ROOF WITH SUN VISOR
2. UPPER SOFT DOOR PANELS
3. SOFT REAR WINDOW
4. FULL WINDSHIELD — HARDCOATED
5. LOWER DOOR PANELS

HARSH ELEMENTS DON'T STAND A CHANCE!

SOFT CAB ENCLOSURE

- Protection for rider and passenger from the elements.
- For added cabin comfort, complete your cab enclosure with Cab Seal Kit.

Maverick

- Includes:**
- Bimini Roof with Sun Visor
 - Full Windshield — Hardcoated
 - Upper Soft Door Panels
 - Front Lower Door Panels
 - Soft Rear Window

715003754 **10 631 zł**

Maverick MAX

- Includes:**
- Bimini Roof with Sun Visor
 - Full Windshield — Hardcoated
 - Upper Soft Door Panels
 - Front Lower Door Panels
 - Soft Rear Window

715003755 **15 025 zł**

CAB SEAL KIT

- (Not illustrated)
- Prevents dirt, dust and wind infiltration in the cab area.
 - Improves cabin comfort for driver and passenger.
 - Recommended with Soft Cab Enclosures.

Maverick

715004433

205 zł

Maverick MAX

715004434

137 zł

DESIGN YOUR OWN CAB.

PICK THE ACCESSORIES OF YOUR CHOICE AND BUILD OR COMPLETE YOUR OWN CAB.

✓ 100% modular components designed to work together:

ROOFS P. 11
WINDSHIELDS P. 15

DOORS P. 19
REAR WINDOWS P. 19

WINDSHIELD

DEVELOPED TOGETHER WITH YOUR MAVERICK TO ENSURE THEY FIT, LOOK AND PERFORM AS THEY SHOULD.

☺
QUANTUM[®] COATING
Our Full Windshield - Hardcoated is made of high-impact-resistant Quantum hardcoated polycarbonate to ensure a long life.



POWERFLIP WINDSHIELD

Allows you to quickly adapt to changing conditions by adjusting the windshield as you go.



100% INTEGRATED

Your Can-Am's standard profiled cage allows our accessories to install easily, with a perfect fit.



Quady Śrem - tel. 61 28 35 657 - email: biuro@sklepatv.pl - www.sklepatv.pl



GLASS WINDSHIELD

- Curved and laminated glass full windshield.
- Seals firmly against the cage and protects rider and passenger from the elements.
- Provides the best optical clarity and abrasion resistance.
- Must be used with Windshield Wiper & Washer Kit to maintain clear visibility during severe riding conditions, such as mud riding.
- Usage of a rear wind protection is recommended.

Maverick, Maverick MAX
715003281 **5302 zł**

EXPERT CHOICE

PROVENT WINDSHIELD

- High-impact-resistant Quantum[®] hardcoated polycarbonate full windshield.
- Controllable vents to manage air flow.
- Optimal performance with full cab enclosure.
- Channels air into the cabin, defogs windshield, fully closes to eliminate air flow.
- One upper vent and one lower vent with pre-filters.
- Formed polycarbonate construction for enhanced rigidity.
- Provides excellent optical clarity and better abrasion resistance.
- Protects driver and passenger from the elements.
- Quick and easy tool-less installation or removal.
- Not compatible with Lonestar Racing roofs.

Maverick, Maverick MAX
715005277 **4006 zł**



Upper vent channels air into the cabin

Lower vents defog windshield

EXPERT CHOICE

TOTAL AIR FLOW CONTROL
Industry's first powered flip windshield

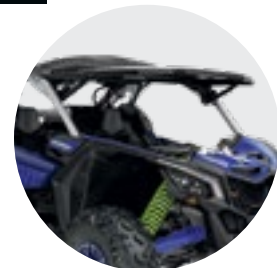

FULLY OPENED
for optimal visibility and ventilation

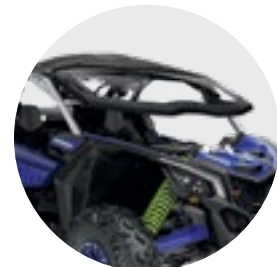

INFINITE POSSIBILITIES IN BETWEEN
depending on protection, visibility and air flow preferences

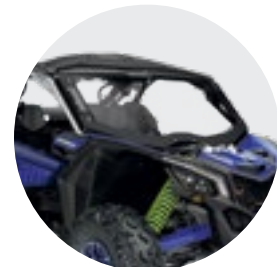

FULLY CLOSED
for maximum protection from the elements

POWERFLIP WINDSHIELD

- The PowerFlip Windshield is equipped with electric cylinders that allow the rider to adjust the windshield opening at the touch of a button.
- Windshield is made of hardcoated polycarbonate with a rubber seal contour and a tinted top section.
- Allows you to quickly adapt to changing conditions by adjusting the windshield as you go.
- Can be fully opened for optimal visibility and ventilation, fully closed for maximum protection from the elements, and in between, you have an infinite number of opening possibilities depending on protection, visibility and air flow preferences.
- Compatible with Can-Am roofs.

Maverick, Maverick MAX
715007097 **6712 zł**

NEW WINDSHIELD WIPER FOR POWERFLIP WINDSHIELD

- An ideal way to keep your windshield clear in rain or while riding through mud and water.
- Wiper from the top allowing windshield pivoting. Includes single-speed wiper and washer-fluid dispenser.
- Wiper mechanism and washer-fluid dispenser perfectly concealed within the vehicle.
- Must be installed with the PowerFlip Windshield (sold separately).

Maverick, Maverick MAX
715006310 **3902 zł**



GLASS WINDSHIELD WITH WIPER & WASHER KIT

- Complete kit that includes the curved and laminated glass windshield with the single-speed wiper and washer fluid dispenser.
- Seals firmly against the cage and protects rider and passenger from the elements.
- An ideal way to keep your windshield clear in rain, or while riding through mud and water.
- Must be used with rear wind protection.

Maverick, Maverick MAX
715003283 **7804 zł**



FULL WINDSHIELD

- High-impact-resistant durable polycarbonate full windshield.
- Formed polycarbonate construction for enhanced rigidity.
- Formulated to be non-yellowing, non-crazing, non-cracking with excellent UV resistance and optical clarity.
- Protects driver and passenger from the elements.
- Quick and easy tool-less installation or removal.
- Must be used with rear wind protection.

Maverick, Maverick MAX
715002907 **2081 zł**



FULL WINDSHIELD - HARDCOATED

- High-impact-resistant Quantum[®] hardcoated polycarbonate full windshield.
- Formed polycarbonate construction for enhanced rigidity.
- Provides excellent optical clarity and better abrasion resistance.
- Protects driver and passenger from the elements.
- Quick and easy tool-less installation or removal.
- Must be used with rear wind protection.

Maverick, Maverick MAX
715004417 **3116zł**

WINDSHIELD WIPER & WASHER KIT

- An ideal way to keep your windshield clear in rain, or while riding through mud and water.
- Includes single-speed wiper and washer fluid dispenser.
- Wiper mechanism and washer fluid dispenser perfectly concealed within the vehicle.

Maverick, Maverick MAXFit with Full Windshield Hardcoated (715004417)
715004762

Maverick, Maverick MAXFit with Glass Windshield (715003281)
715003282 **3116 zł**



HALF WINDSHIELD

- High-impact-resistant durable polycarbonate half windshield.
- Formed polycarbonate construction for enhanced rigidity.
- Formulated to be non-yellowing, non-crazing, non-cracking with excellent UV resistance and optical clarity.



CLEAR WINDSHIELD
715002909 **1463 zł**

- Protects driver and passenger from the elements.
- Features reverse angle lip to deflect air flow.
- Quick and easy tool-less installation or removal.

Maverick, Maverick MAX



TINTED WINDSHIELD
715004291 **1561 zł**

EXPERT CHOICE



REAR MIRROR & CAMERA MONITOR

- Fully waterproof rearview camera and monitor kit.
- Multiple camera feeds can be seen with the rear view camera, to see what you need.
- Unit replaces stock rearview mirror (screen is integrated in the unit's replacement rearview mirror).
- Camera uses infrared light for night vision capabilities.

Maverick, Maverick MAX
715004905 • Black **2087 zł**



SIDE MIRRORS

- Rugged cast aluminum mount with black nylon cover.
- Multi-position adjustable ball-joint mounted mirrors.
- Convex optics for a wide viewing angle.
- Spring-loaded pivots let mirrors fold back completely.
- Door mounted.
- Compatible with Upper Soft Door Panels.
- Sold in pairs.

Maverick, Maverick MAX
715004236 • For stock quarter doors **1289 zł**
715005315 • For aluminum doors



RACING SIDE MIRRORS

- Race-inspired design features rugged black nylon 1/2 construction with coated cast-aluminum mount.
- Dual adjustment provides optimal field of view (FOV).
- Multi-position adjustable ball-joint mounted mirrors.
- Flat optics deliver improved distance perception.
- Spring-loaded pivots let mirrors fold back completely.
- Not compatible with Lonestar Racing Light Racks and Upper Soft Door Panels.
- Sold in pairs.

Maverick, Maverick MAX **1041 zł**
715002898



PERFECT-FIT
Choose ultimate fit and rigidity that sits firmly against the cage for complete rider protection from the elements.

DUNES, DESERT, MUD & TRAIL—COMFORT, PROTECTION & GREAT LOOKS WHEREVER YOU ROAM.



ALUMINUM HALF DOORS

Perfect full door coverage in strong, lightweight aluminum — includes Deluxe Door Handles.



DELUXE DOOR HANDLES

Sturdy inside-outside handles replace door pulls for even faster cockpit entry and exit.

EXPERT CHOICE

ALUMINUM HALF DOORS

- Lightweight half doors made of formed 5/64" (2 mm) thick aluminum.
- Textured black powder coat finish for superior scratch resistance.
- Engineered for maximum rigidity and durability.
- Designed for a perfect fit and seamless integration with the vehicle's lines.
- Contoured with a thick seal for better protection from the elements.
- Easy installation using the standard door frame.
- Include the easy-to-operate Deluxe Door Handles.
- Compatible with the Upper Soft Door Panels, the Window Nets and Upper Door Storage Bags.
- Not compatible with the Lower Door Panel Storage Bags.
- Sold in pairs.

Maverick, Maverick MAX
 715004732 • Front **3642 zł**
Maverick MAX
 715004753 • Rear



DELUXE DOOR HANDLES

- Convert the standard door straps into easy-to-access door handles.
- Include inside and outside handles for each door.
- Greatly facilitate door opening.
- Standard on accessory Aluminum Half Doors.
- Sold in pairs.

Maverick, Maverick MAX **Maverick MAX**
 715004758 • Front **715004860 • Rear**
873 zł **873 zł**



LOWER DOOR PANELS

- Robust injection-molded polypropylene construction designed to match vehicle.
- Extend stock doors at bottom to protect and seal cab area.
- A great-looking add-on.
- Easy and quick installation.
- Sold in pairs.
- Rear Lower Door Panels sold separately.

Maverick, Maverick MAX
 715002903 • Front **1781 zł** **715003751 • Rear**
1810 zł

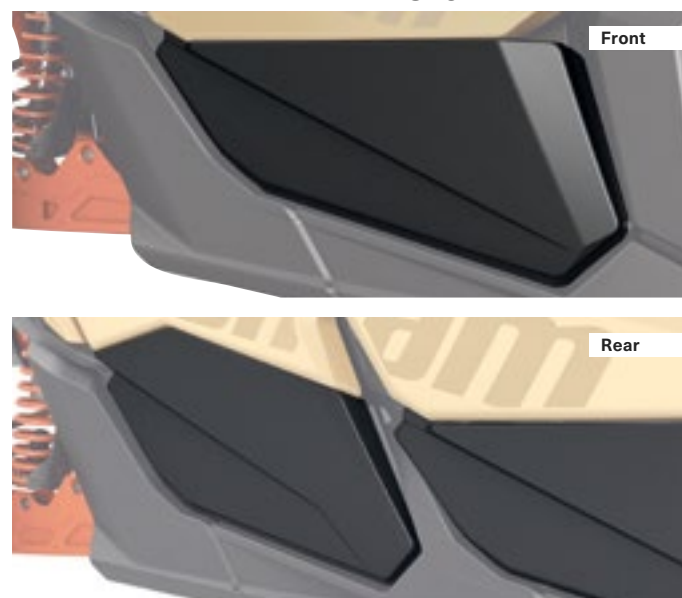

Quady Śrem - tel. 61 28 35 657 - email: biuro@sklepatv.pl - www.sklepatv.pl

EFFECTIVELY REDUCE WIND BACKDRAFTS & DEBRIS INTO YOUR CAB.



WINDOW NETS

- Window mesh screen for added protection from wind.
- Can be easily lowered in seconds.
- Sold in pairs.

Maverick **Maverick MAX**
 715006693 • Front **821 zł** **715004694 • Front** **715006700 • Rear**
792 zł **821 zł**



UPPER SOFT DOOR PANELS

- Weather-resistant panels reinforced with aluminum frame offer good protection from the elements.
- Extend stock quarter doors at the top.
- Made of heavy-duty UV-resistant solution-dyed polyester canvas for excellent resistance to tear and abrasion.
- Zip-down windows made of laminated polished vinyl material for added ventilation.
- To be combined with the Lower Door Panels to obtain complete door kits for your vehicle.
- Not compatible with Racing Side Mirrors.

Maverick (2 doors) **Maverick MAX (4 doors)**
 715007118 **3920 zł** **715003753** **7515 zł**



REAR WIND SCREEN

- Full rear mesh screen reduces windshield backdraft for added cabin comfort.
- Installs quick and easily on roll cage.
- Large white Can-Am logo on black mesh.

Maverick, Maverick MAX (except X mr models)
 715006701 **526 zł**



REAR POLYCARBONATE WINDOW

- High-impact-resistant polycarbonate window.
- Blocks windshield backdraft or dust and rain from entering for added cabin comfort.
- Quick and easy tool-less installation.
- Ready for MTX Audio System Rear Speakers.

Maverick, Maverick MAX (except X mr models)
 715006387 **1486 zł**



SOFT REAR WINDOW

- Clear, flexible window made from transparent vinyl.
- Resists cold-cracking to -4 °F (-20 °C).
- Ideal for preventing backdraft of dust or rain in harsh environments.
- Quick tool-less installation.

Maverick, Maverick MAX (except X mr models)
 715006702 **526 zł**



STAY LOCKED AND LOADED WITH DELUXE EXTERIOR DOOR HANDLES.

HMWPE SKID PLATES

Our Plastic Plates glide smoothly and silently over obstacles, offering great protection in rough terrain. Made of abrasion-resistant thermoformed 3/8" (10 mm) thick High Molecular Weight Polyethylene (HMWPE).

- ✓ Lighter than aluminum
- ✓ Superior stress crack resistance
- ✓ High-impact strength

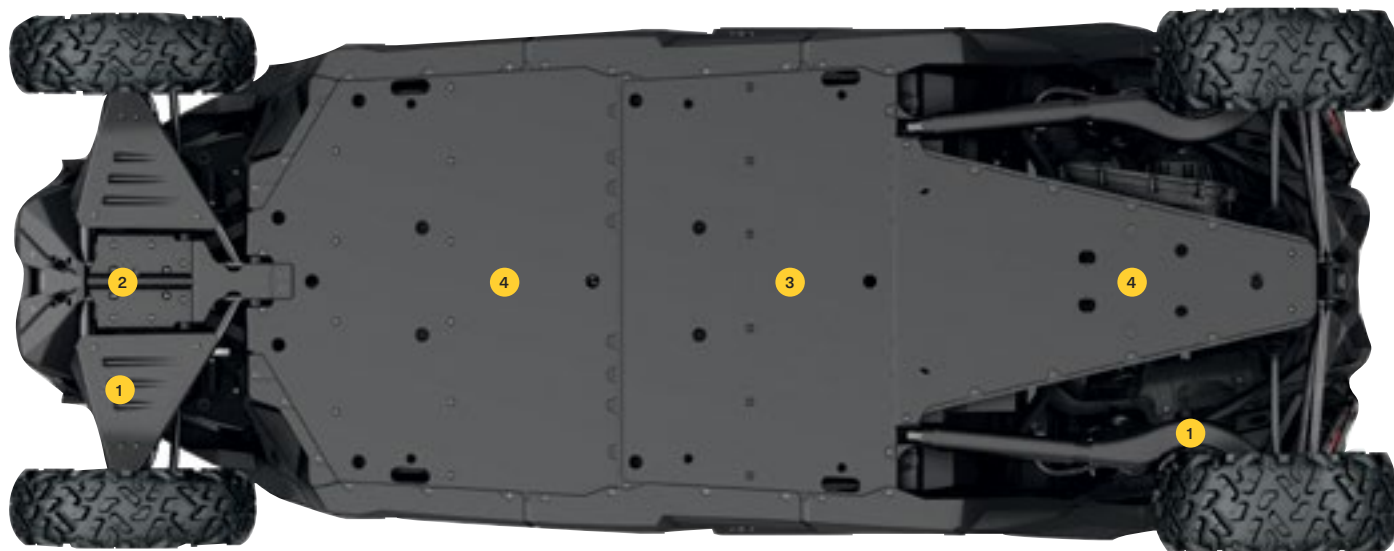

715003747

HMWPE SKID PLATES ARE STANDARD ON MAVERICK X RC MODELS.		MAVERICK 64" MODELS	MAVERICK MAX 64" MODELS	MAVERICK, MAVERICK MAX 72" MODELS (EXCEPT BASE MODELS)	MAVERICK BASE 72" MODELS	MAVERICK MAX BASE 72" MODELS
FULL PROTECTION KIT						
HMWPE Skid Plate Protection Kit		715003713	715003747	715003718	715006767	715006769
INDIVIDUAL HMWPE SKID PLATES						
1	HMWPE Front A-Arm and Trailing Arm Protectors	715002905 1230 zł	715002905 1230 zł	715003552 1417 zł	715003552 1417 zł	715003552 1417 zł
2	HMWPE Front Skid Plate	715003933 464 zł	715003933 464 zł	715003933 464 zł	715003933 464 zł	715003933 464 zł
3	HMWPE Central Skid Plate	—	715003731 998 zł	Standard on these models	—	715003731 998 zł
4	HMWPE Underbelly Plate	715004904 2105 zł	715004904 2105 zł	Standard on these models	715004904 2105 zł	715004904 2105 zł

Some products shown may not be available or homologated in your country. Contact your BRP dealer for local details.

Cennik zawiera sugerowane ceny detaliczne brutto w walucie PLN. Ceny mogą ulec zmianie bez wcześniejszego uprzedzenia. Cennik nie jest ofertą w rozumieniu prawa.

BUMPERS

STRENGTH AND CHARACTER TO ENDURE IT ALL. OUR BUMPERS ARE READY FOR IT.



BETTER CORROSION PROTECTION
Can-Am bumpers are E-Coated for supreme corrosion protection inside and out.

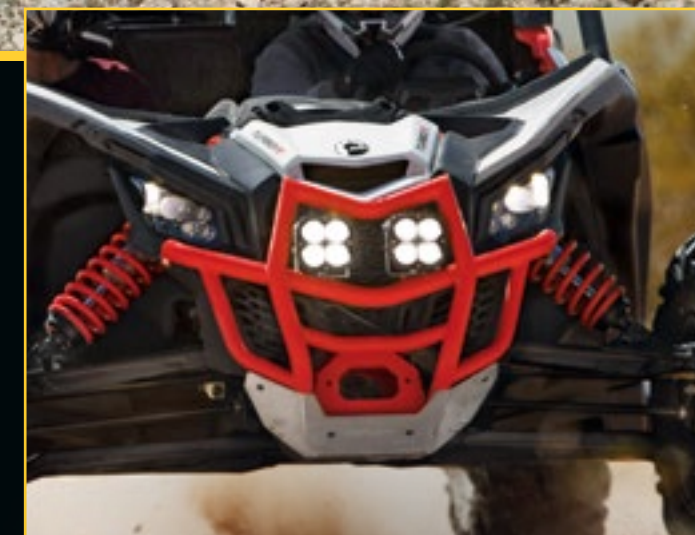

100% INTEGRATED
Seamlessly fit the style and finish of your Maverick.

LIGHT READY
Fully integrated light mounting plate. Multiple light installation options.

Quady Śrem - tel. 61 28 35 657 - email: biuro@sklepatv.pl - www.sklepatv.pl

PROTECT & PUSH YOUR
RIDE WITH CONFIDENCE
THROUGH THE WORST.



FRONT INTRUSION BAR

- Matches vehicle styling.
- Inside and outside anti-corrosion coating with durable powder coat finish steel intrusion bar.
- Tube design reduces obstructed lines of sight and blind spots for better visibility.
- Not compatible with windshields and Lonestar Racing Aluminum Roof.

Maverick, Maverick MAX

■ 715002889 • Black

■ 715003435 • Can-Am Red

1711 zł

1960 zł



REAR CAGE EXTENSION

- Durable 1.5" (3.8 cm) diameter steel tubing.
- Inside and outside anti-corrosion coating with durable powder coat finish.
- Allows holding a spare tire in place (wheel not included).
- Custom tie-down strap for fast tire installation or removal.
- Rear Pre-Runner Bumper required for installation.
- Not compatible with LinQ Pivoting Rack, cargo boxes (except LinQ 20 Gal (73 L) Deluxe Modular Bag) and Lonestar Racing roofs.

Maverick (except X mr models),

Maverick MAX

■ 715002890 • Black

■ 715003434 • Can-Am Red

1289 zł

1561 zł



EXPERT CHOICE

FRONT PRE-RUNNER BUMPER

- Made of 1.5" (3.8 cm) diameter steel tubing with a 1/8" (3 mm) aluminum plate for extra durability.
- Inside and outside anti-corrosion coating with durable powder coat finish.
- Added heavy-duty protection in extreme driving conditions.
- Integrated winch mounting plate and mount points for lights.

Maverick, Maverick MAX

■ 715002878 • Black

■ 715003433 • Can-Am Red

1515 zł

1810 zł



REAR PRE-RUNNER BUMPER

- Extra-durable 1.5" (3.8 cm) diameter steel tubing with a 1/8" (3 mm) aluminum plate.
- Inside and outside anti-corrosion coating with durable powder coat finish.
- Protects vehicle bodywork and exhaust system.
- Rear Receiver Hitch compatible.
- Required for installation of the Rear Cage Extension.

Maverick, Maverick MAX

■ 715002880 • Black

1515 zł

■ 715003436 • Can-Am Red

1810 zł



DUNE FRONT BUMPER

- Made of 1.5" (3.8 cm) diameter aluminum tubing with a 1/8" (3 mm) aluminum plate.
- Inside and outside anti-corrosion coating with durable powder coat finish.
- Provides added protection without sacrificing the agility and performance advantages of a lighter weight design.
- Features a more pronounced attack angle and integrated mounting points for lights.
- Not winch compatible.

Maverick, Maverick MAX

■ 715002961 • Black

■ 715003432 • Can-Am Red

1289 zł

1515 zł



DUNE REAR BUMPER

- Made of 1.5" (3.8 cm) diameter aluminum tubing with a 1/8" (3 mm) aluminum plate.
- Inside and outside anti-corrosion coating with durable powder coat finish.
- Provides added protection without sacrificing the agility and performance advantages of a lighter weight design.
- Protects vehicle bodywork and exhaust system.
- Rear hitch compatible.
- Not compatible with Rear Cage Extension and Lonestar Racing Spare Tire Holder.

Maverick, Maverick MAX

■ 715002962 • Black

■ 715003437 • Can-Am Red

1289 zł

1515 zł



Quady Śrem - tel. 61 28 35 657 - email: biuro@sklepatv.pl - www.sklepatv.pl

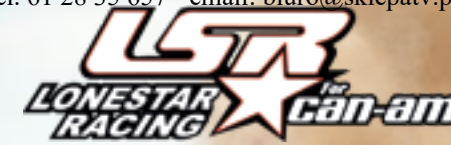

RACING DESIGN FOR PEAK PERFORMANCE.

Race-engineered with a reputation for toughness and style.



X RC / X MR FRONT BUMPER

- Made of 1.5" (3.8 cm) diameter steel tubing with a 1/8" (3 mm) aluminum plate.
- Inside and outside anti-corrosion coating with durable powder coat finish on steel tubing.
- Offers all the essential features required for technical driving: Low front-end protection, support base for winch installation and integrated tow hook.
- Standard on Maverick X rc and X mr models.
- Not compatible with winches with steel cable.

Maverick, Maverick MAX

- 715004741 • Sunburst Yellow
- 715004742 • Octane Blue
- 715004789 • Can-Am Red
- 715004788 • Black

2006 zł

2307 zł



LONESTAR RACING FRONT BUMPER

- Made of 1.5" (3.8 cm) diameter steel tubing with durable powder coat finish and a 1/8" (3 mm) thick aluminum plate for added vehicle-front protection in extreme driving conditions.
- Sleek styling enhances the vehicle's race-inspired look.
- Not winch compatible.
- Not compatible with 10" (25 cm) Baja Designs OnX6 LED Light Bar.



Maverick, Maverick MAX (not compatible with Xmr and Xrc models)

- 715005510 • Hyper Silver
- 715005509 • Black

2006 zł

1810 zł

LONESTAR RACING REAR BUMPER

- Made of 1.5" (3.8 cm) diameter steel tubing with durable powder coat finish.
- Provides additional vehicle-rear bodywork and exhaust system protection in extreme driving conditions.
- Sleek styling enhances the vehicle's race-inspired look.
- Compatible with Lonestar Racing Spare Tire Holder and Lonestar Racing Rear Intrusion Bar.
- Not hitch compatible.



Maverick, Maverick MAX

- 715005511 • Black
- 715005512 • Hyper Silver

1908 zł

2156 zł

ROCK SLIDERS

- Made of heavy-duty 1.5" (3.8 cm) diameter steel tubing.
- Inside and outside anti-corrosion coating with durable powder coat finish.
- Protect vehicle's sides and undercarriage against large obstacles.
- Support plate adds rigidity and style.
- Sold in pairs.

Maverick (except X rc)

- 715002963 • Black
- 715003438 • Can-Am Red

1289 zł

1561 zł

Maverick MAX

- 715003730 • Black
- 715003888 • Can-Am Red

1908 zł

2156 zł



X RC UHMWPE ROCK SLIDERS

- Robust 1/4" (6 mm) UHMWPE construction.
- Include lower body panels and brackets for installation.
- Protect vehicle's sides and undercarriage against large obstacles.
- Lodge tight up against vehicle body for better clearance from obstacles.
- Slide smoothly over obstacles.
- Sold in pairs.

Maverick

715004730

2908 zł



FENDER FLARES

- Extended fender flares made from injection-molded polypropylene.
- Keep mud and debris out of vehicle.
- Designed for quick and easy installation.
- Include front and rear extensions and mounting hardware.

Maverick, Maverick MAX

715002973

1561 zł



Maverick, Maverick MAX

- 715004161 • Can-Am Red

2006 zł



Maverick, Maverick MAX

- 715004162 • Can-Am Red

2156 zł



LONESTAR RACING SPARE TIRE HOLDER

- Made of 1.5" (3.8 cm) diameter steel tubing with durable powder coat finish.
- Adjustable height to fit Can-Am tires up to 30 in.
- Requires Lonestar Racing Rear Bumper and Lonestar Racing Rear Intrusion Bar for installation.
- Cannot hold the Pro Armor Quickshot Wheel Jack and Off-Road Screw Jack.
- Wheel not included.
- Not compatible with the S&B Particle Separator and LinQ accessories intended for the rear of the vehicle.

Quady Śrem - tel. 61 28 35 657 - email: biuro@sklepatv.pl - www.sklepatv.pl

- Maverick, Maverick MAX (except X mr models)**
- 715003922 • Black **1070 zł**
 - 715004166 • Can-Am Red **1289 zł**
 - 715006344 • Hyper Silver **1318 zł**



S3 REAR BUMPER



LONESTAR RACING NUMBER PLATE HOLDER

- Includes a pair of sturdy aluminum number plates that mount on either side of the vehicle rear.
- Not compatible with LinQ Pivoting Rack.
- Numbered decals are available through SCS Unlimited.
- Styling enhances the vehicle's race-inspired look while adding a personal touch.
- Black background.

- Maverick, Maverick MAX**
- 715003943 **919 zł**



S3 FRONT BUMPER

WHEN IT COMES TO MUD-MASTERING ACCESSORIES, S3 HAS THE EDGE IN DELIVERING PERFECT-FIT WINCH-READY BUMPERS FOR WORK, PLAY, AND RECOVERY.

LONESTAR RACING FRONT INTRUSION BAR

- Made of 1.5" (3.8 cm) diameter steel tubing with durable powder coat finish.
- Enhances the racing look of the vehicle.
- Compatible with Lonestar Racing Aluminum Roof only.
- Not compatible with windshields.

- Maverick, Maverick MAX**
- 715003916 • Black **1960 zł**
 - 715004163 • Can-Am Red **2209 zł**
 - 715006342 • Hyper Silver



LONESTAR RACING REAR INTRUSION BAR

- Made of 1.5" (3.8 cm) diameter steel tubing with durable powder coat finish.
- Sleek styling enhances the vehicle's race-inspired look.
- Required for the installation of the Lonestar Racing Spare Tire Holder.
- Not compatible with LinQ mounted accessories and Pre-Filter in the cargo bed.

- Maverick (except X mr models), Maverick MAX**
- 715003918 • Black **1561 zł**
 - 715004164 • Can-Am Red **1810 zł**
 - 715006343 • Hyper Silver



LONESTAR RACING ROCK SLIDERS

- Made of 1.5" (3.8 cm) diameter steel tubing with durable powder coat finish filled with 1/8" (3 mm) aluminum plate.
- Protects vehicle sides from large obstacles.
- Sleek styling enhances the vehicle's race-inspired look.
- "Lonestar Racing for Can-Am" branded.
- Sold in pairs.
- Not compatible with X rc models.

- Maverick**
- 715005514 • Hyper Silver **1810 zł**
 - 715005513 • Black **1561 zł**



- Maverick MAX**
- 715005518 • Hyper Silver **3642 zł**
 - 715005517 • Black **3394 zł**

- Maverick**
- 715004165 • Can-Am Red **1810 zł**



- Maverick MAX**
- 715004343 • Can-Am Red **3590 zł**

S3 FRONT BUMPER

- Made of 1.5" (3.8 cm) diameter steel tubing with a 1/8" (3 mm) aluminum plate for extra durability.
- Inside and outside anti-corrosion coating with durable powder coat finish.
- Added heavy-duty protection in extreme driving conditions.
- Integrated winch support plate and mount points for lights.
- Hook support anchor allows you to keep the winch hook within easy reach when riding in deep mud.
- "S3 for Can-Am" branded.
- Winch Not Included.

- Maverick, Maverick MAX**
- 715004867 • Black **2209 zł**
 - 715005231 • Can-Am Red

REAR WINCH HARNESS

- (Not illustrated)
715006007 **1041 zł**

S3 REAR PULL PLATE

- Offers a solid place to hook onto in case towing is needed.
- Allows you to attach most straps and hooks.
- "S3 for Can-Am" branded.

- Maverick, Maverick MAX**
- 715004870 • Black **625 zł**
 - 715005233 • Can-Am Red



S3 REAR BUMPER

- Made of extra-durable 1.5" (3.8 cm) diameter steel tubing.
- Inside and outside anti-corrosion coating with durable powder coat finish.
- Added heavy-duty protection in extreme driving conditions – protects vehicle bodywork and exhaust system.
- Permits installation of a winch at a higher location to improve accessibility in muddy conditions.
- "S3 for Can-Am" branded.
- Engineered to sustain heavy winch loads without damaging the vehicle's frame.
- Compatible with Can-Am HD and WARN VRX winches – rear winch harness 715006007 is required to install a winch on the bumper.
- Includes a robust recovery hook to facilitate vehicle recovery.
- Winch not included.
- Not EC compliant.

- Maverick, Maverick MAX**
- 715004869 • Black **3018 zł**
 - 715005232 • Can-Am Red

SEAT ACCESSORIES



4-POINT HARNESS

- Exclusive controlled decelerator absorbs energy in case of an accident.
- Designed to offer maximum riding comfort.
- Easy one-click latch and release.
- Patent pending.
- Not EC compliant.

Maverick, Maverick MAX
715003767 • Passenger **1041 zł**
715003766 • Driver **1255 zł**



RETRACTABLE 4-POINT HARNESS

- Convenient harness allows you to move freely in your seat, and at the same time, fully benefit from the extra support given by the 4-point attachments.
- Makes it easier to buckle up and requires fewer adjustments when switching passenger or driver.
- Retractor Protector (707900653) is required for installation on front seats of MAX models.
- Compatible with rear passenger seats on MAX models.
- Standard on Maverick X rs 2018 and up and X rc Turbo R models.

Maverick, Maverick MAX
715005022 • Passenger **1238 zł**
715005021 • Driver **1318 zł**



SEAT BELT SHOULDER PADS

- Provide additional riding comfort by preventing seat belt from rubbing on neck and shoulder.
- Fit with standard 3-point seat belts and Retractable 4-Point Harness.
- Easy Velcro installation.
- Can-Am branded.
- Sold in pairs for driver and passenger.

Maverick, Maverick MAX
715002894 **205 zł**



RETRACTOR PROTECTOR

- (Not illustrated)
- Protective pad required for the installation of the Retractable 4-Point Harness on front seat of MAX models.
- Protects the passengers from the retractor mechanism.
- Sold individually.

Maverick MAX
707900653 **422 zł**

EASY ON, EASY OFF CARGO

LinQ SYSTEM

A BRP EXCLUSIVE, LinQ IS A TOOL-LESS SYSTEM FOR NEAR-INSTANT INSTALLATION OF ACCESSORIES. QUICKLY, EASILY INSTALL AND REMOVE LinQ ACCESSORIES TO TRANSFORM YOUR MACHINE TO FIT THE MOMENT.



YOUR ADVENTURE, OUTFITTED
LinQ trunk boxes, rack extensions, bags, baskets, and gear grips attach quickly for your next expedition.



TOOL-LESS
Twist LinQ fasteners and go!

LinQ ACCESSORY TYPES

- LinQ with 16" base accessories are mounted with LinQ anchors 16 inches apart, ideal for Can-Am ATVs and SSVs, Sea-Doo watercraft, and Ski-Doo snowmobiles.
- LinQ with 36" base accessories are most commonly used as part of LinQ racks for Can-Am Off-Road vehicles.

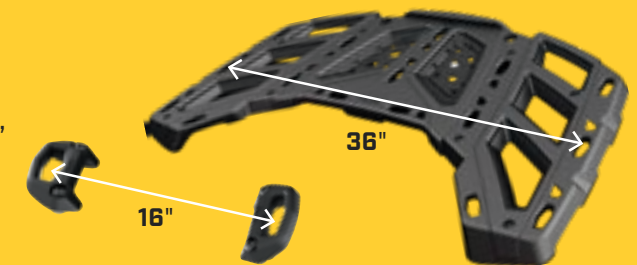







Quady Śrem - tel. 61 28 35 657 - email: biuro@sklepatv.pl - www.sklepatv.pl

LinQ SYSTEM™ ACCESSORIES

- No tools needed: Quickly install and remove accessories by hand
- Equip your Can-Am for specialized tasks in no time
- Sturdy mounting system that holds up to the roughest terrain









LinQ ACCESSORIES WITH 16" BASE p. 33

- LinQ anchors mounted 16 inches apart, center to center.
- Lower loading capacity than the LinQ with 36" base accessories.
- Can be used on Can-Am ATV and SSV vehicles, Sea-Doo watercraft and Ski-Doo snowmobiles.

		MOUNTING LOCATION AND REQUIREMENTS		
	Standard LinQ Rack 715002881 / 715003439 2509 zł / 2798 zł		LinQ Pivoting Rack 715003868 / 715006225 2972 zł / 2659 zł	
	LinQ 4.2 GAL (16 L) COOLER 295100698 1486 zł	LinQ Anchor Adapter Kit 715004960	LinQ Anchor Adapter Kit 715004960	
	LinQ TOOL BOX 715004301 671 zł			LinQ Cargo Base Kit 860201806 138 zł
	LinQ SR 5.5 GAL (21 L) BAG 860201740 1024 zł			
	LinQ 4.5 GAL (17 L) SPORT BAG 860201678 809 zł			
	LinQ DRY BAG 715002875 954 zł			

LinQ ACCESSORIES WITH 36" BASE p. 34

- Mount on LinQ racks often used by Can-Am ORV vehicles.
- Higher loading capacity than the LinQ with 16" base accessories.
- Usage is limited to Can-Am ORV vehicles.

	LinQ 12 GAL (45 L) CARGO BOX 715003879 1139 zł	No further requirements		
	LinQ 23 GAL (86 L) TRUNK BOX 715004923 1486 zł	No further requirements		
	LinQ 32 GAL (124 L) TRUNK BOX 715001748 1839 zł	*Not compatible if the LinQ Pivoting Rack is installed.		
	LinQ 11.5 GAL (43 L) AUDIO CARGO BOX 715003018 3145 zł	No further requirements	No further requirements	Not compatible
	LinQ 8 GAL (30 L) COOLER BOX 715004778 • Black / 715004698 • Grey 1862 zł	No further requirements	No further requirements	
	LinQ PREMIUM STORAGE BAG BY OGIO 715002923 • Black / 715003248 • Camo 2029 zł / 2405 zł	No further requirements		
	LinQ HEAVY-DUTY BASKET 715001215 1139 zł	No further requirements		
	LinQ LOW PROFILE BASKET 715004282 873 zł	No further requirements		

LinQ RACKS & HOLDERS p. 36

	LinQ TOOL HOLDER 715003059 255 zł	No further requirements	No further requirements	Side wall installation: LinQ Adapters 715003058 137 zł
---	--	-------------------------	-------------------------	--



LinQ 4.2 GAL (16 L) COOLER

SR 5.5 GAL (21L) LinQ BAG

LinQ TOOL HOLDER

LinQ Accessories with 16" base



LinQ 4.2 GAL (16 L) COOLER

- Rotomolded construction for exceptional rigidity and durability.
- Premium-quality foam insulation for optimal ice retention.
- Marinized for salt water purposes.
- See table for installation location and requirements.

Maverick, Maverick MAX
295100698

1486 zł



LinQ TOOL BOX

- High precision injected HDPE construction provides rigidity and durability.
- 5 Gal (19 L) maximum capacity.
- Weather-resistant, sealed and lockable cover.
- LinQ Cargo Base Kit (860201806) included.
- Marinized for salt water purposes.
- See table for installation location and requirements.

Maverick, Maverick MAX
715004301

671 zł



LinQ SR 5.5 GAL (21 L) BAG

- Semi-rigid expandable bag.
- 5.5 Gal (21L) capacity.
- LinQ Cargo Base Kit included (860201806) included.
- See table for installation location and requirements.

Maverick, Maverick MAX
860201740

1024 zł



LinQ 4.5 GAL (17 L) SPORT BAG

- 4.5 Gal (17 L) capacity.
- Rigid bottom, semi-rigid top.
- See table for installation location and requirements.

Maverick, Maverick MAX
860201678

809 zł



LinQ DRY BAG

- Fully waterproof roll-top dry bag will securely store and confine your equipment.
- LinQ mounted using heavy-duty rigid plastic base.
- High capacity storage solution (40 L).
- Bottom foam liner for additional equipment protection.
- Integrated handle for easy transportation on/off the vehicle.
- LinQ Cargo Base Kit included (860201806) included.
- Marinized for salt water purposes.
- See table for installation location and requirements.

Maverick, Maverick MAX
715002875

954 zł



Quady Śrem - tel. 61 28 35 657 - email: biuro@sklepatv.pl - www.sklepatv.pl



LinQ 23 GAL (86 L) TRUNK BOX

LinQ Accessories with 36" base

LinQ 12 GAL (45 L) CARGO BOX

- LinQ mounted for easy on, easy off installation.
- Holds cargo safely and securely while riding.
- See table for installation location and requirements.

Maverick, Maverick MAX 1139 zł
715003879



LinQ 23 GAL (86 L) TRUNK BOX

- LinQ mounted for easy on, easy off installation.
- Lockable and weather-resistant.
- Holds cargo safely and securely while riding.
- See table for installation location and requirements.

Maverick (except X mr models), Maverick MAX 1486 zł
715004923



LinQ 32 GAL (124 L) TRUNK BOX

- Equipped with the LinQ System, the rear trunk box plugs in and out in seconds.
- 32 Gal (124 L) load capacity with unobstructed space to maximize storage room and access to the trunk's interior.
- Made of injection-molded polyethylene, double walled in critical areas.
- The fully sealed lid protects your belongings from dust, moisture and the elements.
- No rear tail light.
- Trunk Box Panels available in many colors to match your vehicle (sold separately).
- See table for installation location and requirements.

Maverick (except X mr models), Maverick MAX 1839 zł
715001748 • No rear tail light



LinQ 32 GAL (124 L) TRUNK BOX PANELS

- Color panels to match the LinQ 32 Gal (124 L) to your vehicle.

Maverick, Maverick MAX 278 zł
European Version (EC compliant)

- No rear tail light
- 715001397 • Black
- 715001398 • Yellow
- 715002482 • Light Grey
- 715002483 • White
- 715006121 • Can-Am Red
- 715006122 • Manta Green
- 715006123 • Orange Crush
- 715006124 • Viper Red

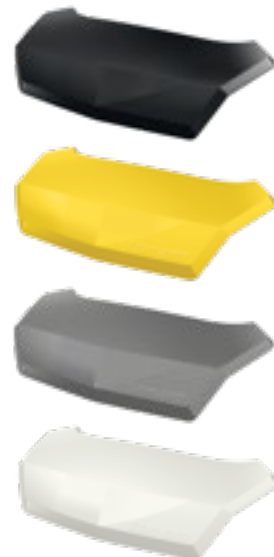

EXPERT CHOICE

LinQ 8 GAL (30 L) COOLER BOX

- Installs without vehicle modification.
- LinQ mounted for easy on, easy off installation.
- Rotomolded construction provides exceptional rigidity and durability.
- Premium-quality foam insulation for optimal ice retention.
- Weather-resistant.
- Integrated, fully removable compartment protects food.
- Robust rubber latches keep the cover tightly closed.
- Convenient drain plug.
- See table for installation location and requirements.

Maverick, Maverick MAX
■ 715004698 • Grey 1862 zł
■ 715004778 • Black



LinQ HEAVY-DUTY BASKET

- Made of high-strength, low-alloy steel.
- LinQ mount for easy on, easy off installation.
- See table for installation location and requirements.

Maverick, Maverick MAX 1139 zł
715001215



LinQ LOW PROFILE BASKET

- Low profile, open basket increases cargo space.
- Perfect for easy access to tools, rope, winch and plow accessories.
- Multiple bungee cord and tie-down anchor points.
- Made of impact-resistant injected polypropylene.
- See table for installation location and requirements.

Maverick, Maverick MAX 873 zł
715004282



LinQ 11.5 GAL (43 L) AUDIO CARGO BOX

- An affordable and quick solution for adding music and storage to your next ride.
- The rear installation does not use any cab space and allows for easy listening at an average speed.
- Mounts on/off easily to hold/carry cargo safely and securely.
- Backlit control panel perfect for night riding.
- Water-resistant speakers.
- The Bluetooth enabled receiver and 6.5" (16.5 cm) speakers are smartly concealed and integrated in the cover.
- Automatic shut-off function protects your battery by turning the system off after 10 minutes of inactivity.
- See table for installation location and requirements.

Maverick, Maverick MAX 3145 zł
715003018



EXPERT CHOICE

LinQ PREMIUM STORAGE BAG BY OGIO

- Tool-less installation and removal thanks to the LinQ System.
- 17.2 Gal (65 L) capacity semi-rigid cargo bag ideal for carrying anything you need on your vehicle.
- Buckle and elastic closure with a rubber seal that protects dust from entering the bag.
- 3-section lid for partial or full access to your bag.
- Inside separators for optimal bag organization.
- See table for installation location and requirements.

Maverick, Maverick MAX
■ 715002923 • Black 2029 zł
■ 715003248 • Mossy Oak Break-Up Country Camo 2405 zł



Inside separators for optimal bag organization

LinQ TOOL HOLDER

- Ultra-versatile tool holder.
- Convenient swivel-latch allows tools to be stored in any orientation.
- Sold in pairs.
- See table for installation location and requirements.

Maverick, Maverick MAX 255 zł
715003059



LinQ ANCHOR ADAPTER KIT

- Allows the installation of 16" LinQ accessories.
- Tool-less installation and removal.

Maverick, Maverick MAX 308 zł
715004960



LinQ CARGO BASE KIT

- Unique mounting fastener usable on any LinQ System accessory.
- Included: 2 LinQ Cargo bases and hardware.

Maverick MAX 138 zł
860201806



TUBE LinQ ADAPTER

- Cage mounted LinQ receiver.
- Included in the LinQ Pivoting Rack assembly.
- Allows the installation of single LinQ mounted accessory.
- Diameter: 1.85" (47 mm).

Maverick, Maverick MAX 145 zł
715004292



LinQ REPLACEMENT PART

- (Not illustrated)
- Unique mounting fastener usable on any LinQ System accessory.
- Tool-less installation and removal.
- Sold in pairs.

Maverick, Maverick MAX 116 zł
715001707

LinQ ADAPTER

- (Not illustrated)
- Allows the installation of the LinQ Tool Holder (715003059) on the Adventure Roof Rack.
- Sold in pack of 4.

Maverick MAX 137 zł
715003058

CARGO BOX NET

- (Not illustrated)
- Solid net designed to secure and assure a compact confinement of your Adventure Roof Rack cargo.

Maverick, Maverick MAX 285 zł
715001371

SPARE TIRE RATCHET TIE-DOWNS

- 3-way ratcheting tie-down strap with loop ends.
- Designed to securely hold spare tires on accessories equipped with integrated spare tire attachment points.
- Adjustable to accommodate most common UTV tire sizes.
- Ratchet and junction ring made of durable zinc-plated steel.
- Required for spare tire attachment on Adventure Roof Rack.

Maverick (except X mr models), Maverick MAX 152 zł
280000606



LinQ PIVOTING RACK



EXPERT CHOICE

ADVENTURE ROOF RACK

- Ideal cargo solution for packing everything you need to live your Off-Road experience fully and completely.
- Built with light weight 1.25" (3.2 cm) diameter steel tubing.
- Integrated mounting points for lights can hold up to eight pod-type LED lights (six front and two back) or a 40" (102 cm) LED bar (front).
- Features anchor points for spare-tire attachment.
- LinQ anchor on both side.
- Spare Tire Tie-Downs sold separately.
- Add the Cargo Box Net to secure and confine your cargo in the rack.

NEW Maverick Loads up to 40 lb (18 kg)
715006225 **2659 zł**

Maverick MAX Loads up to 75 lb (34 kg)
715003868

2972 zł

BUILD YOUR OWN ADVENTURE ROOF RACK!

Shown here with:
Spare Tire with Tie-downs
Baja Designs XL80 LED Lights and LinQ tool holders.



EXPERT CHOICE

LinQ PIVOTING RACK

- LinQ latched rack allows for extra LinQ mounted accessories or for carrying a spare tire (tire not included).
- Includes custom tie-down strap for fast spare tire installation or removal.
- Gas-cylinder pivot action, locks in the raised position.
- Trunk Boxes over 20 Gal (74 L) do not fit on the vehicle when the rack is installed.
- Not compatible with Rear Intrusion Bars, Rear Cage Extension and Lonestar Racing Aluminum Roofs.

Maverick (except X mr models), Maverick MAX
■ 715002881 · Black **2509 zł**
■ 715003439 · Can-Am Red **2798 zł**



EXPERT CHOICE

SHOULDER STORAGE BAG

- Bag attaches in unused space between the seats to increase your vehicle's cargo capacity.
- Installs between the rear seats only on MAX models.

Maverick (except X mr models), Maverick MAX (rear only)
715004277

497 zł



FRONT SHOULDER STORAGE BAG

- Opens on each side so that both front and rear passengers can access the bag's content.
- Installs between the driver and passenger seats on MAX models.

Maverick MAX
715004888

671 zł



OVERHEAD STORAGE BAG

- Weather-resistant bag, holds your gear safely and securely while riding.
- Makes smart use of your overhead space to increase your vehicle's cargo capacity by 2.6 Gal (10 L).
- Semi-rigid construction renders it flexible enough to fit odd-shaped loads.
- Touchscreen-compatible clear front pocket allows for easy access to your smartphone.
- Not compatible with the Bimini Roof.

Maverick, Maverick MAX
715004275

497 zł



UPPER DOOR STORAGE BAGS

- Weather-resistant, they'll hold your gear safely and securely while riding.
- Bags attach on stock quarter doors to increase your vehicle's cargo space.
- Each bag is designed as a 1.3 Gal (5 L) capacity pocket also equipped with inner netting compartments.
- Semi-rigid construction renders them flexible enough to fit odd-shaped loads.
- Sold in pairs.

Maverick, Maverick MAX
715004276

625 zł



LOWER DOOR PANEL STORAGE BAGS

- Weather-resistant, they'll hold your gear safely and securely while riding.
- Bags attach on Lower Door Panels to increase your vehicle's cargo space.
- Each bag is designed as a 1.6 Gal (6 L) capacity pocket also equipped with inner netting compartments.
- Semi-rigid construction renders them flexible enough to fit odd-shaped loads.
- Sold in pairs.
- Not compatible with aluminum doors and Off-Road Screw Jack.
- Lower add-on doors required for installation.

Maverick, Maverick MAX
715004355

792 zł



SOFT STORAGE BAG

- (Not illustrated)
- 11.8 Gal (45 L) capacity soft cargo bag designed with vehicle's rear in mind to maximize potential storage.
- 3 sections.
- Weatherproof.

Maverick, Maverick MAX
715003759 • Black

769 zł

STORAGE 2.6 GAL (10 L) BAG

- Roll-top dry bag for fully protecting your cargo from the elements.

Maverick, Maverick MAX
269502121

163 zł



LIGHTS



BUILD YOUR LIGHTING SYSTEM

Refer to page 44.

DEVELOPED BY THE SCIENTISTS OF LIGHTING TO SHINE FARTHER AND SURVIVE BEYOND THE BEATEN PATH— ALL WITH A LIFETIME WARRANTY.

EXPERT CHOICE

40" (102 CM) BAJA DESIGNS ONX6 ARC LED LIGHT BAR

- 252W light bar producing 29,000 lumens.
- Equipped with 24 Cree XM-L2 LEDs.
- Driving/Combo light pattern for smooth blend of light for both near field applications and distance.
- Designed for installation onto Light Support Bar equipped roofs.
- Requires Light Power Cable and Light Support Bar.

Maverick, Maverick MAX
710006818

8808 zł



29,000 LUMENS

40" (102 cm) OnX6 Arc Combo

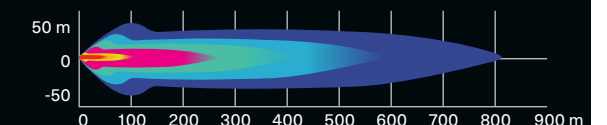

10" (25 CM) BAJA DESIGNS ONX6 LED LIGHT BAR

- 108W light bar producing 12,460 lumens.
- Equipped with 6 Cree XM-L2 LEDs.
- Driving/Combo light pattern for smooth blend of light for both near field applications and distance.
- Dual intensity (high/low) settings.
- Designed for installation onto Pre-Runner and Dune bumpers and/or Light Support Bar equipped roofs.
- Requires Light Power Cable.

Maverick, Maverick MAX
710006819

2325 zł



12,460 LUMENS

10" (25 cm) OnX6 Combo

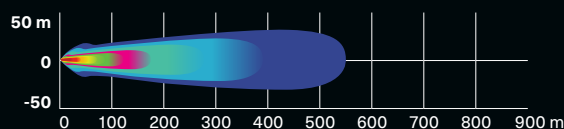

BAJA DESIGNS XL SPORT LED LIGHTS

- 26W per spot producing 3,150 lumens.
- Equipped with 4 Cree XP-G2 LEDs per spot.
- High Speed Spot features a longer and narrower beam focus for illumination farther down.
- Designed for installation onto Pre-Runner and Dune bumpers and/or Light Support Bar equipped roofs.
- Require Light Power Cable.
- Sold in pairs.
- Dimensions: 4.5" x 4.5" (11.4 cm x 11.4 cm).

Maverick, Maverick MAX
710006821

2180 zł



3,150 LUMENS

XL Sport Spot

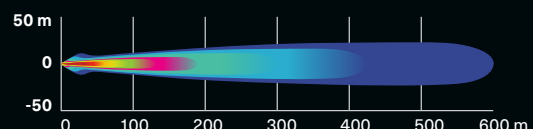

BAJA DESIGNS SQUADRON SPORT LED LIGHTS

- 26W per spot producing 3,150 lumens.
- Equipped with 4 Cree XP-G2 LEDs per spot.
- Designed for installation onto Pre-Runner and Dune bumpers and/or Light Support Bar equipped roofs.
- Wide cornering light pattern designed specifically for cornering, dust and/or fog conditions.
- Require Light Power Cable.
- Sold in pairs.
- Dimensions: 3" x 3" (7.6 cm x 7.6 cm).

Maverick, Maverick MAX
710006820

1268 zł



3,150 LUMENS

Squadron Sport Wide Cornering

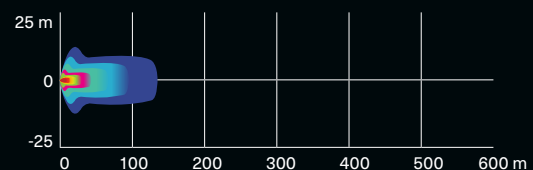

BAJA DESIGNS XL80 LED LIGHTS

- 80W per spot producing 9,500 lumens.
- Equipped with 4 Cree XHP50 LEDs per spot.
- Dual intensity (high/low) settings.
- Driving/Combo light pattern for smooth blend of light for both near field applications and distance.
- Designed for installation onto Pre-Runner and Dune bumpers and/or Light Support Bar equipped roofs.
- Require Light Power Cable.
- Sold in pairs.
- Dimensions: 4.5" x 4.5" (11.4 cm x 11.4 cm).

Maverick, Maverick MAX
710005041

4379 zł



9,500 LUMENS

XL80 Combo

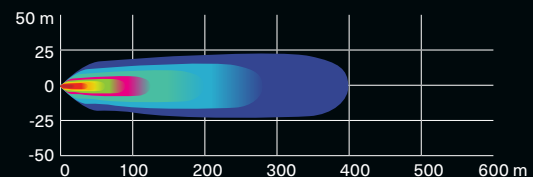

BUILD YOUR LIGHTING SYSTEM. Refer to page 44.



LONESTAR RACING LIGHT RACK

LOW-PROFILE LIGHT MOUNT SOLUTION FROM LONESTAR RACING.

LONESTAR RACING 40" (102 CM) LED LIGHT BAR RACK

- Designed for use with 40" (102 cm) Baja Designs OnX6 Arc LED Light Bar.
- Enhances the vehicle's race-inspired look.
- Compatible with Aluminum Roof, Lonestar Racing Aluminum Roof and Sport Roof.
- Not compatible with Racing Side Mirrors and PowerFlip Windshield.
- Lights sold separately.

Maverick, Maverick MAX
715003920

1561 zł



LONESTAR RACING LIGHT RACK

- Designed for use with Baja Designs XL80 LED Light and Baja Designs XL Sport LED Light.
- Accommodates up to two pairs of XL Lights.
- Not compatible with Racing Side Mirrors and PowerFlip Windshield.
- Compatible with Lonestar Racing Aluminum Roof, Aluminum Roof and Sport Roof.
- Lights sold separately.

Maverick, Maverick MAX
715003948

1561 zł



CHASE LIGHTS

- Designed by Can-Am to make you visible to vehicles riding behind you, especially in dusty or harsh conditions.
- Feature in-dash switches to activate one of the two modes and to choose among 11 different high-visibility colored light patterns (blue, red and yellow).
- Trail Mode: Serves as a tail light and as a brake light.
- Race Mode: Displays light patterns and serves as a brake light (brake light function can be deactivated for racing applications).
- Modular to allow installation with rear roll cage mounted accessories.
- Plug-and-play installation.

Maverick, Maverick MAX
715002887

3359 zł



LIGHT SUPPORT BAR

- Sleekly styled rugged aluminum construction.
- Accommodates light bars and spotlights with or without any roof and windshield combination.
- Full vehicle width to allow the installation of any large LED light bar.
- Required for light installation on vehicle's roof.
- Not compatible with Lonestar Racing Aluminum Roof.
- Lights sold separately.

Maverick, Maverick MAX
715003529

1070 zł



MOUNTING KIT FOR 39" (99 CM) LED LIGHT BAR

- (Not illustrated)
- Required for installation of the 39" (99 cm) Double Stacked LED Light Bar.
- Includes wiring and support bracket.
- Light Support Bar required for installation.

Maverick, Maverick MAX
715005822

561 zł

LIGHT POWER CABLE

- (Not illustrated)
- Required for installation of 10" (25 cm), 15" (38 cm) and Double Stacked LED Light Bars and 4" (10 cm) Round LED Lights.
- For bumper and roof mounting locations.

Maverick, Maverick MAX
715003417

255 zł

39" (99 CM) DOUBLE STACKED LED LIGHT BAR (270 WATTS)

- Equipped with 54 5W Cree LEDs.
- 24,300 lumens.
- See table for mounting location and installation.

Maverick, Maverick MAX 3442 zł
715004007



24,300 LUMENS

Lights up to more than 2900 ft (900 m) in front of the vehicle and around 115 ft (35 m) wide on each side.

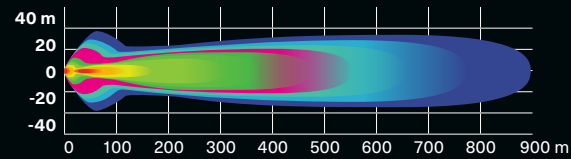

15" (38 CM) DOUBLE STACKED LED LIGHT BAR (90 WATTS)

- Equipped with 18 5W Cree LEDs.
- 8,400 lumens.
- Rugged and waterproof.
- See table for installation location.

Maverick, Maverick MAX 1759 zł
715002934



8,400 LUMENS

Lights up to more than 1900 ft (580 m) in front of the vehicle and around 65 ft (20 m) wide on each side.

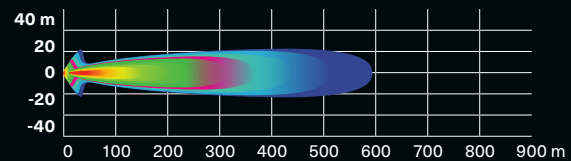

10" (25 CM) DOUBLE STACKED LED LIGHT BAR (60 WATTS)

- Equipped with 12 5W Cree LEDs.
- 5,400 lumens.
- Rugged and waterproof.
- Packs a big punch for its size.
- See table for installation location.

Maverick, Maverick MAX 1433 zł
715002933



5,400 LUMENS

Lights up to more than 1500 ft (460 m) in front of the vehicle and around 65 ft (20 m) wide on each side.

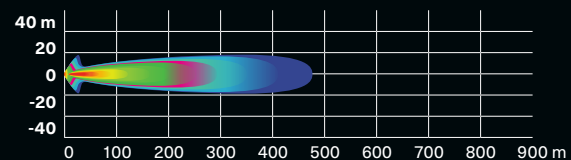

4" (10 CM) ROUND LED LIGHTS (2 X 25 WATTS)

- 25W LED spotlights.
- 1,800 lumens.
- Rugged and waterproof.
- Includes basic wiring and switch.
- Can-Am branded grill.
- Sold in pairs.
- Not EC compliant.
- See table for installation location.

Maverick, Maverick MAX 1759 zł
715002935



1,800 LUMENS

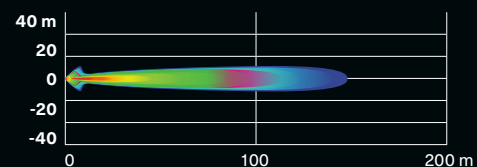

Quady Śrem - tel. 61 28 35 657 - email: biuro@sklepatv.pl - www.sklepatv.pl

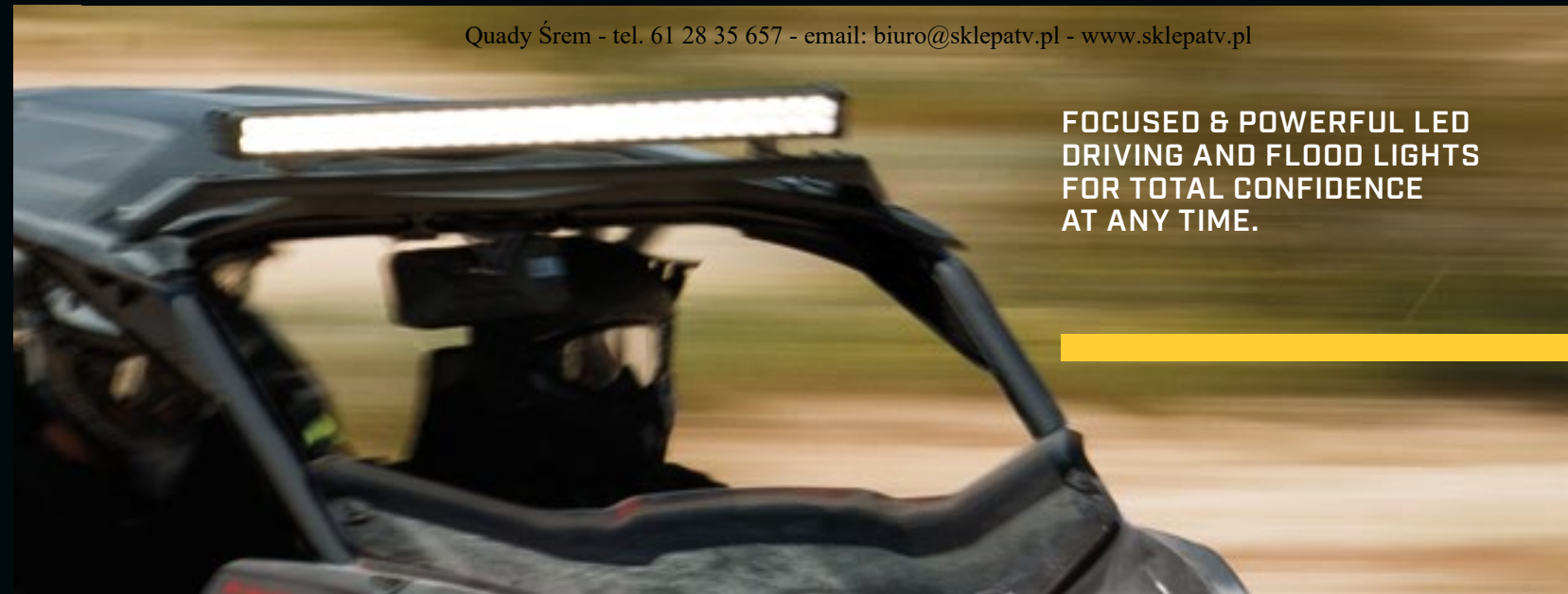

FOCUSED & POWERFUL LED DRIVING AND FLOOD LIGHTS FOR TOTAL CONFIDENCE AT ANY TIME.

3.5" (9 CM) LED LIGHTS (2 X 14W)

- 14W LED lights producing 1,260 lumens each.
- Equipped with 6 high power LEDs in a heavy-duty die cast aluminum housing.
- Features 2 attachment points — if one attachment point fails due to a collision, rotate to the next channel point and re-mount the light.
- Sold in pairs.
- CE certified.

Maverick, Maverick MAX

LED DRIVING LIGHTS

- Spot lens for a narrow and long light beam spread, ideal when driving at higher speeds.

1174 zł

715003666

LED FLOOD LIGHTS

- Flood lens for a wide light beam spread, ideal for working applications like plowing or for cornering, dusty or foggy riding conditions.

715003665 **997 zł**



1,260 LUMENS

LED Driving Lights

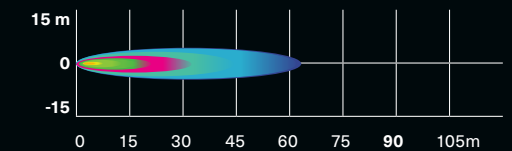

LED Flood Lights

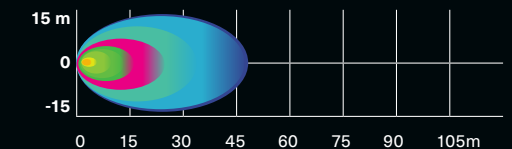

CAN-AM LED SIGNATURE LIGHTS

- Add style with a more aggressive look.
- Use bright and energy efficient LEDs.
- Do not give additional lighting for driving.

Maverick, Maverick MAX 927 zł
715003673



DOME LIGHT

- LED array integrates perfectly with vehicle.
- Wiring included.
- Can be installed on cage or roof, with or without roof liner.

Maverick, Maverick MAX 336 zł
715002455



BUILD YOUR LIGHTING SYSTEM. Refer to page 44

BUILD YOUR LIGHTING SYSTEM. Refer to page 44



BUILD YOUR LIGHTING SYSTEM IN 3 EASY STEPS.

1 CHOOSE YOUR MOUNT POINT	2 CHOOSE YOUR LIGHTS								
	BAJA DESIGNS LIGHTS				CAN-AM LIGHTS				
	10" (25 cm) LED Light Bar	40" (102 cm) Arc LED Light Bar ONX6	XL Sport LED lights (sold in pairs)	XL80 LED Lights (sold in pairs)	10" (25 cm) Double Stacked LED Bar	15" (38 cm) Double Stacked LED Bar	39" (99 cm) Double Stacked LED Bar	4" (10 cm) Round LED Lights (sold in pairs)	3.5" (9 cm) LED Driving Lights or Flood LED Lights (sold in pairs)
	Consult p.39-40 for more information on these lights.				Consult p.41-43 for more information on these lights.				
Front Pre-Runner or Dune Bumpers	710006819 2325 zł PLUS 715002885 503 zł (Power Cable)	NA	710006821 2180 zł PLUS 715002884 331 zł (Power Cable)	710005041 4379 zł PLUS 715002884 331 zł (Power Cable)	715002933 1433 zł PLUS 715003417 255 zł (Power Cable)	715002934 1759 zł PLUS 715003417 255 zł (Power Cable)		715002935 1759 zł PLUS 715003417 255 zł (Power Cable)	715003666 1174 zł or 715003665 997 zł PLUS 715003417 255 zł (Power Cable)
Lonestar Racing Front Bumper	NA	NA	710006821 2180 zł PLUS 715002884 331 zł (Power Cable)	710005041 4379 zł PLUS 715002884 331 zł (Power Cable)				715002935 1759 zł PLUS 715003417 255 zł (Power Cable)	715003666 1174 zł or 715003665 997 zł PLUS 715003417 255 zł (Power Cable)
Lonestar Racing Front Bumper and X rc & X mr Front Bumper	NA	NA	NA	NA	NA	NA	NA	NA	715003417 255 zł (Power Cable) NA
Light Support Bar or Adventure Roof Rack	710006819 2325 zł PLUS 715002885 503 zł (Power Cable)	710006818 8808 zł PLUS 715002885 503 zł (Power Cable)	710006821 2180 zł PLUS 715002884 509 zł (Power Cable)	710005041 4379 zł PLUS 715007049 509 zł (Power Cable)	715002933 1433 zł PLUS 715003417 255 zł (Power Cable)	715002934 1759 zł PLUS 715003417 255 zł (Power Cable)	715004007 3442 zł PLUS 715005822 561 zł (Light Mounting Kit)	715002935 1759 zł PLUS 715003417 255 zł (Power Cable)	715003666 1174 zł or 715003665 997 zł PLUS 715003417 255 zł (Power Cable)
Lonestar Racing 40" (102 cm) LED Light Bar Rack	NA	710006818 8808 zł PLUS 715002885 509 zł (Power Cable)	NA	NA	NA	NA	NA	NA	NA
Lonestar Racing Light Rack	NA	NA	710006821 2180 zł PLUS 715002884 509 zł (Power Cable)	710005041 4379 zł PLUS 715007049 509 zł (Power Cable)	NA	NA	NA	NA	NA

3 ORDER

ORDER ALL PART NUMBERS IN INTERSECTING BOX

*Note: when installing more than one light kit, additional light power cable or mounting kit is required.

*All lights are intended for Off-Road use only.

BAJA DESIGNS LIGHT POWER CABLE

(Not illustrated)
• Required for installation of Baja Designs LED lights onto roof or bumper.

Maverick, Maverick MAX

10" (25 cm) Baja Designs OnX6 LED Bars
715002885 **503 zł**

Baja Designs XL Sport LED Lights & Baja Designs Squadron Sport LED Lights
715002884 **331 zł**

Baja Designs XL80 LED Lights
715003729 **526 zł**

AUDIO & COMMUNICATION SYSTEMS

YOUR RIDE, YOUR TRAIL, YOUR TUNES: PUMP UP THE VOLUME WHEREVER YOU MAY ROAM WITH THESE RUGGEDLY ENGINEERED AUDIO ACCESSORIES!

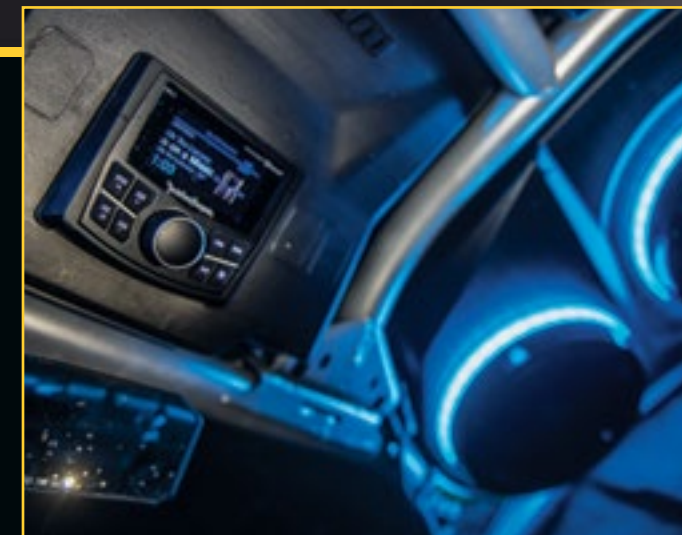
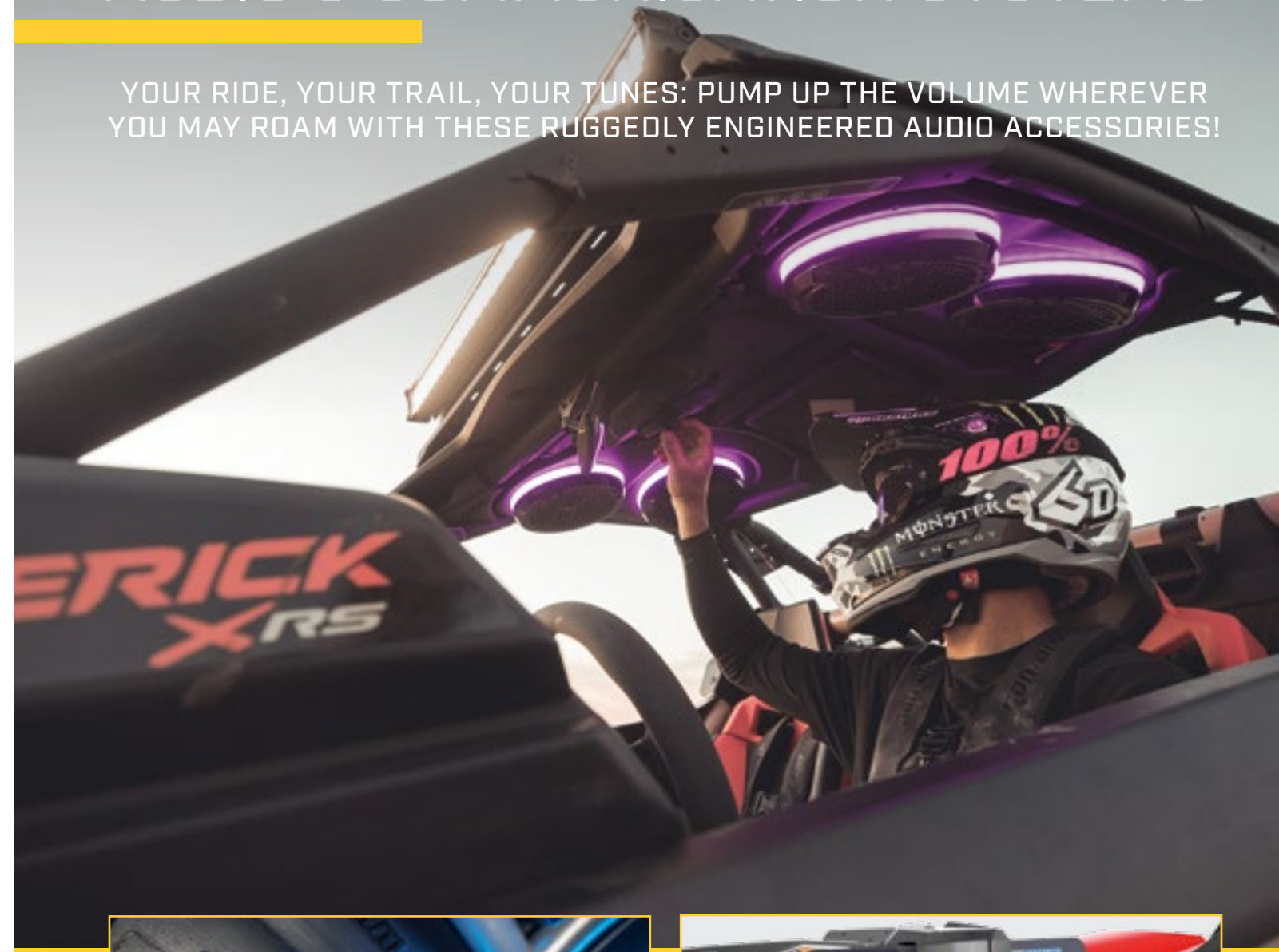

AUDIO ROOF

Part punchy stereo, part roof—upgrade your Maverick instantly with a single plug.



ELECTRONIC DEVICE HOLDER

Adjustable, secure mount to take your smartphone, tablet, or electronic device along for the ride!

HEART-POUNGING SOUND PERFORMANCE TO MATCH YOUR MAVERICK.

Quady Śrem - tel. 61 28 35 657 - email: biuro@sklepatv.pl - www.sklepatv.pl



EXPERT CHOICE

AUDIO ROOF

- Full roof with sleek, built-in audio.
- Fully sealed and waterproof.
- Easy to install: One wire connects the roof to the vehicle's electronics.
- One 400 RMS and 800 Peak Watt amplifier, and one Head Unit supplied by Rockford Fosgate Audio.
- Multi-coloured RGB LED accent lighting around each speaker.
- 2.7" Colour Display with Bluetooth and Pandora connectivity.
- Signal Sensor device (715007706) is required for Audio Roof (715004900).
- Not compatible with Upper Soft Doors.

Maverick
Four 8" speakers
715004900

NEW Maverick MAX
Six 8" speakers
715006709 **17497 zł**



CAN-AM SUBWOOFER

- Powerful Rockford Fosgate Underseat 10" Subwoofer speaker box.
- Easy plug-and-play connections to Audio Roof system (wiring included).
- Sturdy construction tough enough to withstand harsh environments and sealed against moisture and dirt.
- Requires 1 Amplifier kit (715007227) for 2 subwoofers.
- Fits two per vehicle: under driver or passenger seat.
- For installation with Can-Am Audio roof 2up, requires the Signal Sensor (715007706).

Maverick, Maverick MAX
715004956 **2601 zł**



CAN-AM AMPLIFIER KIT

- A powerful 400 W amplifier to feed up to two Underseat Subwoofers.
- Easy plug-and-play connections to Audio Roof system and subwoofer.
- Installation plate and wiring included.
- Signal device (715007706) is required for Audio Roof (715004900).

Maverick, Maverick MAX
715007227 **2601 zł**



MTX CENTRAL SPEAKERS

- Top mounted central speaker case holding two 6.5" (16.5 cm) / 100W speakers.
- Designed to be Can-Am-tough in the most demanding riding conditions.
- Perfect add-on to the Complete MTX Audio System for a 7-speaker system or as a stand-alone system by plugging the AUX input jack directly into your music device.
- Not compatible with LoneStar roofs.

Maverick MAX
715004748 **3729 zł**



COMPLETE MTX AUDIO SYSTEM

- Bluetooth 5⁺ equipped 400W RMS / 800W peak audio system by MTX.
- Designed to be Can-Am-tough in the most demanding riding conditions.
- Includes front-dashboard and rear-roll-cage mounted stereo speakers and head unit with an integrated 6.5" (16.5 cm) subwoofer.
- Add the Electronic Device Holder to securely hold your Bluetooth device ready to play your favorite tunes.

Maverick, Maverick MAX
715002873 **6677zł**



RUGGED RADIOS CAR-TO-CAR SYSTEM

- Perfect for communicating with friends and family on group rides.
- Push-to-talk button conveniently mounted on the steering wheel.
- Includes radio mounting bracket, helmet speaker, mic kit and base charger.
- May be synched with the Rugged Radios Intercom System (715002891).
- 2-4 mile range.

This kit includes:

- RH-5R Rugged Radios 5-Watt Dual Band Handheld Radio
- Helmet Speaker/Mic Kit
- Push-to-talk buttons
- Mounting bracket
- Base station charger

Maverick, Maverick MAX
715003440



EXPERT CHOICE

ELECTRONIC DEVICE HOLDER

- A great in-ride entertainment system platform.
- Robust injected-polypropylene construction allows for right fit and easy installation.
- Adjustable unit safely holds most tablets and smartphones measuring between 5.1" (13 cm) and 10" (25.4 cm) (with protective case).
- Combines seamlessly with Complete MTX Audio System and Rugged Radios Intercom System.
- Allows the installation of Garmin Montana 680T GPS.
- Integrated storage (1 Gal [3.8 L] capacity) with access to the dash 12V outlet for device charging.

Maverick, Maverick MAX
715002874 **746 zł**



Integrated storage with access to the 12V outlet for device charging

RUGGED RADIOS INTERCOM SYSTEM

- Specifically designed to facilitate clear in-vehicle communication between driver and passenger(s).
- Expandable to 4 people.
- Includes music port for enjoying your favorite tunes.
- Seamless integration with in-dash switch panel.
- May be synched with the Rugged Radios Car-To-Car System (715003440).

Maverick, Maverick MAX
715002891 **3411 zł**

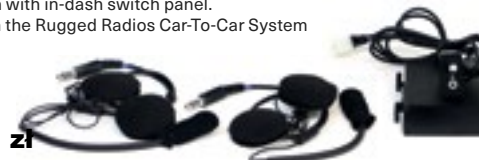

RUGGED RADIOS HELMET HEADSET KIT FOR REAR PASSENGERS

- Additional 12' (3.7 m) cables and Helmet Speaker/Mic Kits to upgrade your 2-person intercom system into a 4-person system.

With Rugged Radios Intercom System
715004380 **1093 zł**



ELECTRICAL & ELECTRONIC



AUXILIARY BATTERY INSTALLATION KIT

(Not illustrated)

- Allows you to add a second 18Ah battery for a dual battery setup necessary to power auxiliary electrical components such as sound systems or winches.
- Equipped with an IP67-rated waterproof electronic module that will prevent your auxiliary electrical components from draining your starting battery.
- Kit includes an additional battery junction block, all necessary wiring and the battery holder.
- Both batteries are perfectly integrated, in stock location, behind the passenger seat.
- Additional battery (410301203), plus battery hardware (250000282) sold separately.

Maverick, Maverick MAX **1318 zł**
715006315

CTEK BRP 5.0 BATTERY CHARGER

- CTEK, the manufacturer of the smartest battery chargers in the world, has produced a BRP specific charger for all BRP products.
- CTEK Charger is built to meet the demanding arctic conditions.
- Ask your dealer for more information.

860200997



LIGHTED WHIP FLAG

- A must for riding the dunes.
- 5W Cree LED.
- 5 colored lenses to allow personalization.
- Glow-through whip, quickly removable and replaceable pole.
- Increases vehicle's visibility.
- Meets most dune-area requirements.
- Die cast aluminum base, acetal hand nut.
- Includes mounting brackets and wiring.
- 4' (1.2 m) flag mounts on top of the roll cage.
- Can be installed on both sides of a vehicle.

Maverick, Maverick MAX
715002886

1417 zł

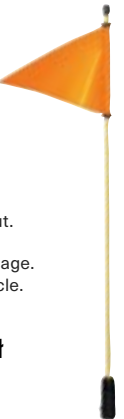

HEATED SEAT

- 25W seat heater delivers chill-free riding comfort.
- Hi/Low temperature settings allow you to control the desired degree of warmth.
- This kit includes one carbon fiber seat heater, foam sheet and in-dash switch.
- Installs directly in the original seat cushion.
- Heated Accessories Wiring Harness (710005757) is required for front seats installation.
- Harness (715006004) is required for rear-seat installation.

Maverick, Maverick MAX
715006112

613 zł



USB POWER OUTLET KIT

- Recharges your electronic devices while riding* (smartphone, MP3, heating gear, etc.).
- Dual port USB connectors.
- *The power outlet is not capable of recharging all device types while riding.

Maverick, Maverick MAX
219400510



HEATED VISOR OUTLET

- Strategically positioned on vehicle to maintain your agility.
- Optional visor outlet that delivers fog-free riding.
- Quick and easy installation.
- Sold individually.
- Heated Visor not included.

Maverick, Maverick MAX
715001246

274 zł



HEATED ACCESSORIES WIRING HARNESS

(Not illustrated)

- Electric harness required to hook up and operate front heated seats, heated steering wheel and grab bar.

Maverick, Maverick MAX **561 zł**
710005757



WINCHES & HITCHES

WARN⁺ VRX

- Extreme IP68-rated waterproof sealing keeps the elements out.
- Durable all-metal construction.
- Black powder-coated finish and stainless steel fasteners for corrosion resistance.
- Robust clutch design based on 70+ years of WARN 4WD hub lock know-how.
- Load-holding brake for great control.
- Smooth and reliable all-metal three-stage planetary gear train.
- Dash-mounted rocker control and corded remote.
- Limited lifetime warranty (mechanical), 3-year warranty (electrical).
- Pulling strength capability of 4,500 lb (2,041 kg).
- Winch Electrical Harness (715003585) and winch compatible front bumper are required for installation.

WARN VRX 45 WINCH

- 50 ft. of 1/4" (15 m of 6.3 mm) wire steel cable.
- Roller fairlead.
- Winch Electrical Harness (715003585) and a Front Pre-Runner Bumper or X mr/X rc Front Bumper are required for installation.

Maverick, Maverick MAX
715006110 **2617 zł**



WARN VRX 45-S WINCH

- 50 ft. of 1/4" (15 m of 6.3 mm) synthetic rope.
- Cast aluminum fairlead.

Maverick, Maverick MAX
715006111 **3117 zł**



CAN-AM HD HAWSE FAIRLEAD

- A must when upgrading your winch with a synthetic cable, this corrosion-proof aluminum hawse fairlead will prevent the cable from snapping in a corner of a roller fairlead and from wearing prematurely due to the rough surface of the worn roller guide.
- Must be used with synthetic cables only.

Can-Am HD winch
715006426

212 zł



WARN HAWSE FAIRLEAD

- Double-powder-coated construction.
- Required to use the Synthetic Winch Cable (705015070) on Warn winches.
- To be used with synthetic winch cables only.

705208797

474 zł



ROLLER FAIRLEAD

- Suggested when changing the wire rope.
- Heavy-duty replacement fairlead for winches.

With Can-Am HD winch
710007082

205 zł



CAN-AM HD

- Ergonomic clutch handle.
- Rugged all-steel gears and bushings for more torque and durability.
- Automatic 100% load-holding brake.
- Sealed solenoid for all-weather protection.
- Weather sealed corded remote and dash mounted switch.
- EC compliant.
- Winch Electrical Harness (715003585) and winch compatible front bumper are required for installation.

CAN-AM HD 4500

- Pulling strength capability of 4,500 lb (2,041 kg).
- 43' of 15/64" (13.1 m of 6.3 mm) wire steel cable.
- Heavy-duty 4-way roller fairlead.
- Winch Electrical Harness (715003585) and a Front Pre-Runner Bumper or X mr/X rc Front Bumper are required for installation.

Maverick, Maverick MAX
715006416 **1535 zł**



EXPERT CHOICE

CAN-AM HD 4500-S

- Pulling strength capability of 4,500 lb (2,041 kg).
- 50' of 1/4" (15.2 m of 6.35 mm) wire synthetic cable.
- Corrosion-proof aluminum hawse fairlead.

Maverick, Maverick MAX
715006417

2087 zł



WARN WIRED REMOTE CONTROL

- This kit allows winch owners to add the hand-held remote to their stock winch.
- EC compliant.
- Harness (710001023) is required to use remote control on a vehicle with a factory installed winch.

With Warn winch
710001002 **285 zł**



CAN-AM HD WIRED REMOTE CONTROL

- This kit allows winch owners to add the hand-held remote to vehicles with their stock winch.
- EC compliant.
- Remote control (710007050) and connection socket are included.

With Can-Am HD winch
715006504 **96 zł**



SYNTHETIC WINCH CABLE

- 50' of 1/4" (15.2 m of 6.35 mm) synthetic cable for Warn winch.
- Warn Hawse Fairlead (705208797) is required when upgrading to a synthetic cable to avoid damage and premature wear of the cable.

With Warn winch
705015070 **804 zł**

- 50 ft. of 3/16" (15.2 m of 4.8 mm) synthetic cable for winches.
- Hawse Fairlead (715006426) required when upgrading to a synthetic cable to avoid premature cable damage and wear.

With Can-Am HD winch
715006430

619 zł



WIRE ROPE REPLACEMENT

- 55' of 1/4" (16.8 m of 6.35 mm) wire rope for Warn winch kit.

With Warn winch
715006699 **349 zł**

- 43' of 15/64" (14.3 m of 6.3 mm) wire rope.
- 4,500 lb (2,041 kg) pulling strength.

With Can-Am HD winch
705014978 **86 zł**



SYNTHETIC CABLE EXTENSION

- Lightweight 1/4" (6.3 mm) diameter, easy to handle and won't rattle in cargo box.
- Easily attaches to winch cable to provide additional 50' (15.2 m) of distance.
- 4,500 lb (2,041 kg) single line capacity.

715001120 **723 zł**



X RC / X MR REAR TOW HOOK

- Offers a solid place to hook onto in case towing is needed.
- Allows you to attach most straps and hooks.
- Made of rugged 3/16" (5 mm) steel plate and 5/8" (16 mm) steel hook tube.
- Standard on Maverick X rc and X mr models.

Maverick, Maverick MAX
715004450 **359 zł**



WIRELESS REMOTE CONTROL

- The system is quick and easy to install, thanks to a wiring harness with an integrated antenna and all necessary mounting hardware.
- Allows you to operate your winch from anywhere within a 50' (15.2 m) radius, increasing your recovery options.
- All components are weatherproof.

With Warn winch
715002542 **916 zł**



WINCH ELECTRICAL HARNESS

- (Not illustrated)
- Required for winch installation.

Maverick, Maverick MAX
715003585 **538 zł**

REAR HITCH

- Rugged lightweight steel construction.
- E-coated finish.
- Fixed mounting point for trailer ball to provide vehicle with towing capabilities.
- This hitch offers 1,300 lb (590 kg) of towing capacity.
- Hitch ball not included.

Maverick, Maverick MAX
715002883 • Black **625 zł**

715003938 • Can-Am Red

792 zł



PERFORMANCE



GRIP LIKE NEVER BEFORE



Can-Am exclusive:
Respond to Off-Road conditions like never before with 4WD powered by Smart-Lok™ Technology.

Smart-Lok™ is the most advanced Off-Road differential at your command. It's a fully lockable on-the-fly front differential with electronically controlled automatic modes that always returns maximum traction in every condition, period.



GET THE PERFORMANCE YOU CRAVE WITH UPGRADES WORTHY OF OUR RACERS.

LONESTAR RACING HEAVY-DUTY SHIFT PLATE & KNOB

- The shift plate is made from durable stainless steel and bolts into place for a secure fit.
- The kit comes with a billet aluminum Lonestar Racing shift knob.
- Offers improved durability for the performance-oriented driver.

Maverick, Maverick MAX 715004866 **671 zł**

LONESTAR RACING MUD FLAPS WITH BRACKETS

- These bolt-on mud flaps make a great addition.
- Durable chromoly brackets.
- Protect trailing arms, rotors and CVs from rocks and debris.
- Sold in pairs.

Maverick, Maverick MAX 715004865 **1289 zł**

LONESTAR RACING OUTER TOE LINK BOXED GUSSETS

- Protect and strengthen the middle radius rod links from rough riding conditions.
- Include high-grade steel bolts.

Maverick, Maverick MAX 715004868 **625 zł**



1 START WITH THE SMART-LOK™ DIFFERENTIAL

SMART-LOK™ DIFFERENTIAL

- Can-Am-exclusive Smart-Lok™ technology constitutes a true full lockable on-the-fly front differential with electronically controlled automatic modes.
- Choose your differential settings according to your riding need: "2x4" for rear wheel traction only, "4x4 Front Diff Lock" for a fully locked 4-wheel drive, and "4x4 Smart Modes" that offer preset, intelligent calibrations for your type of riding.
- Using multiple input sources, "Smart Modes" will instantaneously engage locking with the right load at the right moment to procure maximum traction while retaining low-speed maneuverability, allowing for optimal placement and a feeling of confidence.
- The Smart-Lok™ Kit comes standard with the Trail Mode.
- Mud, Rock and Trail Activ modes can be added by installing an additional Smart Mode Module (sold separately) to fine-tune your riding environment.
- Requires Performance Half Shafts (2x) and Front Differential Kit for installation.

Maverick
produced after January 1, 2017
Maverick MAX
705402371 **7230 zł**

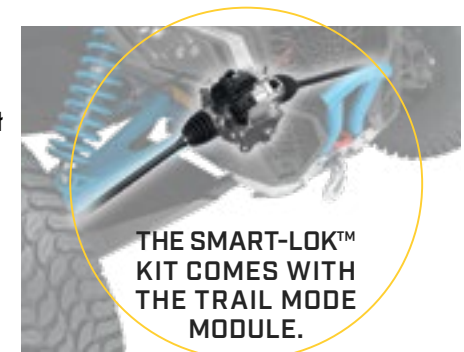

2 GET THE SMART-LOK™ INSTALLATION KIT & PERFORMANCE HALF SHAFT

SMART-LOK™ INSTALLATION KIT

- (Not illustrated)
- Includes all necessary hardware and wiring for Smart-Lok™ Differential installation.

Maverick
produced after January 1, 2017
Maverick MAX
2018 and prior
715004746 **1786 zł**



PERFORMANCE HALF SHAFT

- High-performance design ideal for Off-Road use, with superior wheel power and acceleration for racing, dunes and desert riding.
- Includes CVs, Shaft and Boots with the best suited geometry for your Can-Am vehicle.

Maverick, Maverick MAX
(64" models)
705401634 **1128 zł**

Maverick, Maverick MAX
(72" models)
705402048 **1128 zł**



3 FINE-TUNE YOUR RIDING ENVIRONMENT WITH A SMART MODE MODULE (OPTIONAL)

These modules allow you to add the **Mud**, **Rock** or **Trail Activ** Smart Mode to vehicles equipped with the Smart-Lok™ Differential Kit.
• Only one Smart Mode Module can be installed at a time.

POWER THROUGH DEEP MUD

- Designed to deliver superior traction in the deepest mud holes.
- When high engine torque and/or slippage is detected, Smart-Lok™ will fully lock the front end.
- The system will stay locked until throttle release.

MUD SMART MODE MODULE

Maverick, Maverick MAX 715005282 **769 zł**

DRIVE WHERE IT ROCKS

- Designed to help cross challenging rocks.
- When high engine torque is detected at low vehicle speed, Smart-Lok™ will progressively lock the front end and will stay engaged until throttle release to prevent wheel slippage and provide optimal traction.
- The progressive engagement allows for easier steering when maneuvering the vehicle.

ROCK SMART MODE MODULE

Maverick, Maverick MAX 715005283 **769 zł**

LET THEM TRAIL BEHIND

- Designed for aggressive riding delivering the ultimate cornering precision.
- When high engine torque and/or an increase in vehicle speed is detected, Smart-Lok™ will progressively engage the front end and maintain it engaged until throttle release or vehicle speed reduction.
- The progressive engagement allows for lower smooth steering effort.

TRAIL ACTIV SMART MODE MODULE

Maverick, Maverick MAX 715005284 **769 zł**

Quady Śrem - tel. 61 28 35 657 - email: biuro@sklepatv.pl - www.sklepatv.pl



FIRE EXTINGUISHER

- Ideal for grease, oil and electrical fires.
 - Fits with Lonestar Racing Fire Extinguisher Support Kit.
 - Not EC compliant.
- 295100833**



LONESTAR RACING QUICK RELEASE CLUTCH COVER PINS

- This kit will allow you to take off your clutch cover in seconds to access the belt tool-lessly.
- Includes 4 stainless steel "quick release" pins with clips and tethers.
- Replaces all clutch cover screws.
- This product affects the clutch cover sealing. It is highly recommended to use this product under dry riding conditions only.

Maverick, Maverick MAX 497 zł
715005045

LONESTAR RACING HEAVY-DUTY REAR BOXED RADIUS ROD SUPPORT PLATE

- Double-layered radius rod support plate made of high-grade steel.
- Reinforces your rod mounting location on the frame while adding a mean racing look to your vehicle.
- Easy to install.

Maverick, Maverick MAX 1018 zł
715005046

LONESTAR RACING FIRE EXTINGUISHER SUPPORT

- Quick-release support that allows you to slide the fire extinguisher out in a matter of seconds in an emergency situation.
- Made of billet anodized black aluminum.
- Provides you with the safety and security of having dependable emergency equipment on board.
- Fits 1.85" (4.7 cm) tubing.
- Can be fixed everywhere on the cage.
- Comes with both billet mounts, quick-pull pin, mounting plate and 2 clamps.
- Fire extinguisher sold separately.
- "Lonestar Racing for Can-Am" branded.

Maverick, Maverick MAX 919 zł
715003734

EXPERT CHOICE

YOSHIMURA SLIP-ON EXHAUST

- Developed in collaboration with Yoshimura.
- Made from 304-grade stainless steel with brushed aluminum tip.
- Better sounding, better looking and 19% lighter than stock muffler.
- USDF/USDA approved spark arrester.
- Fuel injection system tuning not required.
- ROHVA and EPA compliant.
- Not EC compliant.

Maverick, Maverick MAX 7365 zł
715005183 · In-Line Triple

715002882 **6024 zł**



X RC BRAKE PEDAL

- Brake pedal with larger foot surface.
- This improves ergonomics and control for the rider in rock climbing conditions.

Maverick, Maverick MAX 255 zł
715004901

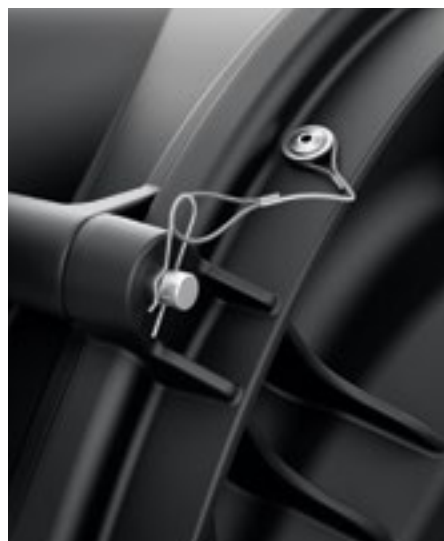

Quady Śrem - tel. 61 28 35 657 - email: biuro@sklepatv.pl - www.sklepatv.pl



OFF-ROAD SCREW JACK

- Race-inspired screw-type design for lifting your vehicle and changing flats fast and effortlessly while on the trail.
- Can be easily operated with any standard socket wrench or impact gun (1/2" [13 mm] drive).
- Integrated support base to facilitate mounting on spare tire carriers.
- Features two fixed attachment points for secure lift spot.
- Height can be adjusted between 7.5" (19 cm) and 42.5" (108 cm).

Maverick, Maverick MAX 2613 zł
715006190



HIGH OUTPUT 172HP UPGRADE KIT

- Performance upgrade kit for Maverick 2017 models only.
- Gain 18 HP for a total of 172 HP.
- Includes: Intercooler with fan, fuel pump catalyst and high performance belt.
- Installation must be done by an authorized BRP dealership to preserve the vehicle's warranty.
- C.A.R.B. Executive Order #D-799U.

Maverick, Maverick MAX (2017 models) 7152 zł
715004700



ARCHED LOWER SUSPENSION LINKS

- Arched lower links to free up more ground clearance.
- Standard on X mr and X rc models.

Maverick, Maverick MAX 1018 zł
715005066 • 72" models

715005065 • 64" models

971 zł



RADIATOR RELOCATOR

- Relocates stock radiator to rear of cage.
- Protects it from debris and rocks.
- Prevents cooling performance loss in muddy condition.
- Reduces hot air in the cabin.
- Easy to clean.
- Includes support hardware and hoses.
- Not compatible with any bed accessories, Rear Cage mounted accessories, Complete MTX Audio system and Upper Soft Doors (except LinQ 8 Gal [30 L] Cooler Box).
- Radiator (709200703) is required for installation on 2017 models.

Maverick, Maverick MAX 6180 zł
715004937

SNORKEL PRE-FILTER

- Pre-filter specifically for snorkels.
- Adds extra protection to your engine in harsh riding conditions.
- Helps keep air filter cleaner.
- Filter blocks particles larger than 0.005" (0.13 mm).
- Necessary to maintain vehicle warranty when tracks are installed.

Maverick, Maverick MAX (with Snorkel kit) 532 zł
715005599



SNORKEL KIT

- Raises point of engine and CVT air intakes so vehicle can be semi-submersed in water or mud without the engine taking in water.
- Not compatible with S&B Particle Separator, LinQ Pivoting Rack, Lonestar Racing Rear Intrusion Bar or any rear panels or windows.
- Sealed Air Box 707800780 (sold separately) is required for installation on models manufactured before January 1, 2018.
- Standard on Maverick X mr models.
- Not EC-compliant.

Maverick, Maverick MAX (2019 and prior) 3590 zł
715003733



*WARNING: Any modifications or addition of accessories may affect the handling of your vehicle. It is important to take the time to get familiar with the vehicle once modifications are made to understand how to adapt your driving behavior accordingly. Do not tamper with unauthorized modifications or install equipment not specifically certified by BRP for the vehicle. These modifications have not been tested by BRP and they may increase the risk of injury or loss of control, or render the vehicle illegal to ride. Ask your authorized BRP dealer for suitable available accessories for your vehicle.

EMERGENCY KIT

- Complete emergency kit provides all essential equipment and supplies to get out of most unfavorable situations powersport enthusiasts may find themselves in.
- Includes jumper cables, air compressor, tire-repair kit, first-aid kit, ratchet tie-down, duct tape, 3,300 lb (1,500 kg) tow strap, zip-ties and cloth rags.

Maverick, Maverick MAX

715004359

694 zł



PERFORMANCE TWIN AIR FILTER

- The best choice for the harshest conditions.
- Multiple staged oiled filtering foam for superior dust retaining capacity with high air flow.
- Washable and reusable.

Maverick, Maverick MAX

715002895

515 zł



FOAM REPLACEMENT

(Not illustrated)

- Replacement foam for Performance Twin Air Filter.

Maverick, Maverick MAX

707800713

205 zł

COVERS & ADD-ONS



TRAILERING COVER

(Not illustrated)

- Heavy-duty canvas made of UV-resistant solution-dyed polyester.
- Inner soft liner protects windshield and colored panels from abrasion.
- All high-abrasion areas are reinforced with a double canvas layer.
- Weather-resistant trailering cover protects your vehicle during storage and transportation.
- Opening for fuel cap and cabin access on passenger side.
- Quick and easy installation.
- Designed to perfectly fit your vehicle with or without Can-Am accessories.

Maverick

715005813

1711 zł

Maverick MAX

715005814

2156 zł

BOLT-ON¹ RETRACTABLE RATCHETING TIE-DOWNS

- Perfect for transporting your powersport vehicle or securing loads.
- Mounts easily: Bolts on any flat surface (e.g., truck bed or frame).
- 1" x 6' (2.5 cm x 1.8 m) tie-down strap with heavy-duty stitching that delivers a 500 lb (226 kg) working load strength and 1,500 lb (680 kg) break strength.
- Convenient retractable push button automatically slackens, spools and stores away strap, while the ratchet mechanism tightens the strap snugly to secure your vehicle or load into place.
- Rubber ratcheting handle provides firm grip, and the hook is vinyl coated to protect whatever surface it hooks into.
- Sold in pairs.

295100737

165 zł



RATCHET TIE-DOWNS

- 400 lb (181 kg) safe working load.
- 1" x 10' (2.5 cm x 3 m) strap with Sea-Doo, Ski-Doo and Can-Am logos.
- Deluxe ratchet with rubber handle.
- Coated S hooks.
- Pack of 2.

860200447 • Black/Grey

86 zł



APACHE TRACK SYSTEMS



EACH TRACK HAS A SPECIFIC PURPOSE AND IS DESIGNED WITHOUT COMPROMISE FOR WORK AND PLAY. WHETHER IT'S FOR DEEP SNOW RIDING, TRAIL RIDING OR FOR HEAVY LOADS, APACHE TRACKS ARE AKIN TO FLOATING ACROSS THE TERRAIN.

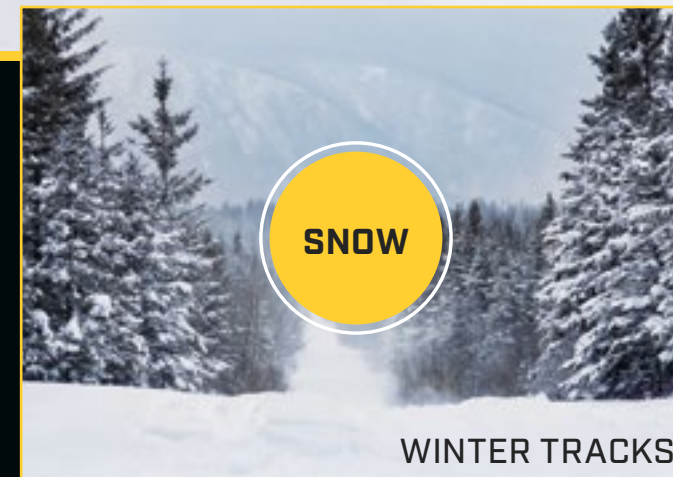

WINTER TRACKS

APACHE BACKCOUNTRY

Finally explore winter with no traction limitations and no compromise, thanks to the unmatched performance of Apache Backcountry track kits. Engineered to thrive in the deepest snow—for work or play. Don't let winter stand in the way.



YEAR-ROUND TRACKS

APACHE 360, 360 LT

Adapt your track setup to the conditions you'll be riding in and the purpose of your ride with the Apache 360 LT system: our all-season, all-terrain masterpiece.

Quady Srem - tel. 61 28 35 657 - email: biuro@sklepatv.pl - www.sklepatv.pl

WINTER TRACKS

GET THE MOST OUT OF YOUR CAN-AM VEHICLE THIS WINTER FOR ALL YOUR ENDEAVORS.

The same technology behind our world-renowned snowmobiles is at your command. With a larger contact patch, and more aggressive track design, travel beyond what you thought possible with the best snow performance.

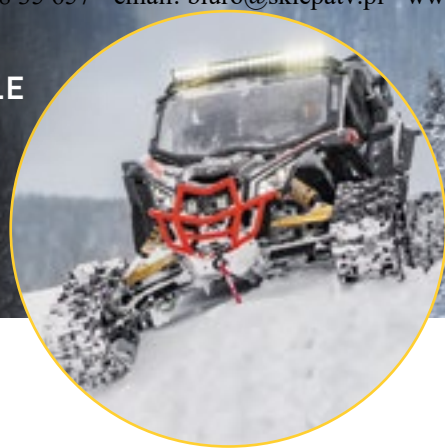

COVERED BY A
1-YEAR WARRANTY

COVERED BY A
2-YEAR WARRANTY

YEAR ROUND TRACKS

WORK & PLAY YEAR ROUND THROUGH MUD, SNOW & ALL TYPES OF TERRAIN.

Rise above terrain and weather, with the Apache 360 LT track kits — the upgrade that takes the Can-Am experience to another level. Designed for superior traction and carrying heavier loads in soft terrain, 360LT track kits can be installed on ATV and SSV vehicles and used for exploring and completing tough tasks.

APACHE BACKCOUNTRY

Efficient frame and rail design ensures weight is evenly distributed

Added ground clearance of 6.4" (16.2 cm)

Aggressive track design with a 2" (5 cm) lug height for maximum traction

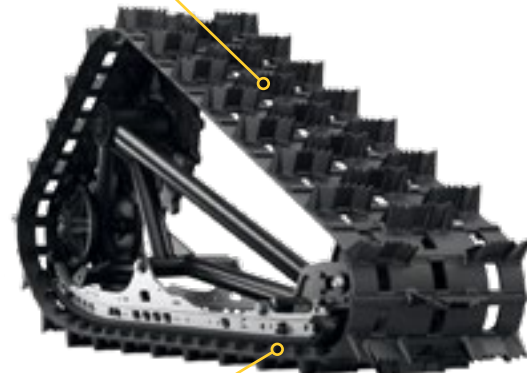
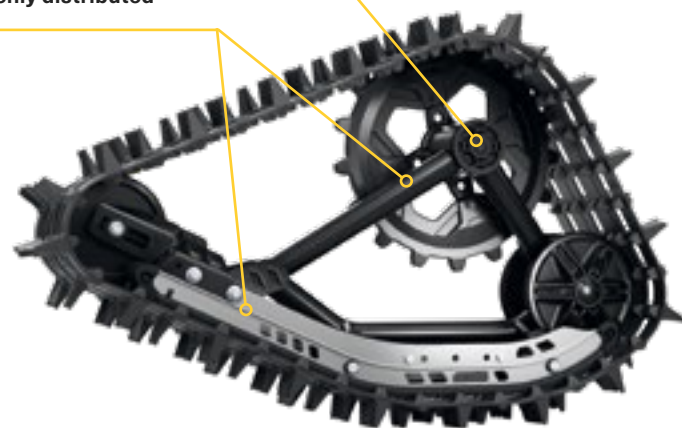

Largest contact patch anywhere: 37% more than the Apache 360 LT

APACHE 360 LT

Added ground clearance of 4.5" (11.4 cm)

Quick & easy installation



Total ground surface area of 2,079.7 in² (13,417 cm²)



Unique adjustable contact patch system to tackle the toughest conditions

Rubber over molded heavy-duty double bearing wheels and offset wheel spacing reduce friction and vibration while ensuring reliability

APACHE BACKCOUNTRY LT TRACK SYSTEM

- Tracks designed to deliver the best snow performance on the market with unmatched flotation level and traction on snow surface.
- Large contact patch, 37% bigger than the Apache 360 LT.
- Impressive added ground clearance of 6.4" (16 cm) helps keep the vehicle over the snow.
- Lightweight snowmobile-inspired rail design.
- Aggressive track design with 2" (5 cm) lug height for maximum traction on snow.
- Apache Backcountry LT Mounting Kit, Track DPS Module and Engine and CVT Pre-Filter are required.
- Fine-tune your track system using extra Idler Wheels, Sliders with Vespel Inserts and Rail Ice Scratcher.
- For winter use only.

Maverick, Maverick MAX **35 078 zł**
715004734

NEW RAIL ICE SCRATCHERS

- Provide additional lubrication in hard and icy conditions.
- Rail mounted, small, light.
- Design expands on coil concept to allow reversing without damage.
- Easily stored when not in use.

Apache Backcountry Track System
860201728



SLIDERS WITH VESPEL[†] INSERTS

- Use DuPont Vespel inserts for less friction.
- Longer life.
- Can be cut to desired length.
- 8 needed per vehicle.
- Sold individually.

Apache Backcountry and Apache Backcountry LT Track System
503194815

416 zł



APACHE 360 LT TRACK SYSTEM

- Multifunctional tracks designed to support heavy loads and to fit on most Can-Am Off-Road vehicles.
- Front wheel height adjustment provides enhanced attack angle and better performance over rough terrain when raised or increased contact patch for improved flotation when lowered.
- Average ground clearance increase of 4.5" (11.4 cm).
- 1" (2.5 cm) lugs in the front and 1.25" (3.2 cm) in the back.
- Apache 360 LT Mounting Kit, Track DPS Module and Engine and CVT Pre-Filter Kit are required.
- Reliable heavy-duty build.
- EC compliant.
- Recommended for use on snow only for Maverick.

Maverick, Maverick MAX **26 379 zł**
715005103

APACHE 360 LT MOUNTING KIT

- (Not illustrated)
- Required for installation of the Apache 360 LT Track System.
- Track DPS Module and Pre-Filter not included.

Maverick, Maverick MAX
64" models **3793 zł** 72" models **4912 zł**
715004392 715004393

TRACK DPS MODULE

- (Not illustrated)
- Innovative DPS module that ensures speedometer accuracy and optimized steering assist, making for perfect track control and riding ease.
- Required to install the Apache Track Systems.
- Not sold in Europe

Maverick, Maverick MAX **636 zł**
715004707

APACHE BACKCOUNTRY LT MOUNTING KIT

- (Not illustrated)
- Required for installation of the Apache Backcountry Track LT System.
- DPS module and Pre-Filter are required and sold separately.

Maverick, Maverick MAX
64" models **4209 zł** 72" models **4771 zł**
715004397 715004394

NEW EXTRA WHEEL KIT

- Additional wheel kit for Backcountry LT rear tracks.
- Reduces drag and rolling resistance in hard snow conditions or when transporting heavier loads.
- Extends slider life in hard snow conditions.
- Includes two wheels, cross shaft and mounting hardware per kit to service one track corner.
- Up to two kits per rear track can be installed.

Apache Backcountry LT Wheel kit
715006293 **458 zł**

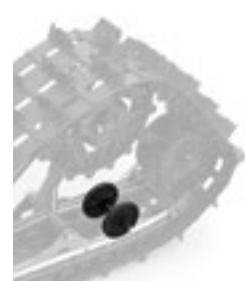

Required to install the Apache Backcountry and Apache 360 LT Track Systems

ENGINE & CVT AIR INTAKE PRE-FILTER

- Adds extra protection to your engine in harsh riding conditions.
- Helps keep air filter cleaner.
- Filter blocks particles larger than 0.007" (0.19 mm).
- Easy installation.
- Not compatible with S&B Particle Separator.
- Necessary to maintain vehicle warranty when tracks are installed.

Maverick, Maverick MAX (except X mr models)
715005600 **532 zł**



SNORKEL PRE-FILTER

- Pre-filter specifically for snorkels.
- Adds extra protection to your engine in harsh riding conditions.
- Helps keep air filter cleaner.
- Filter blocks particles larger than 0.005" (0.13 mm).
- Necessary to maintain vehicle warranty when tracks are installed.

Maverick, Maverick MAX (with Snorkel kit)
715005599 **532 zł**



PROMOUNT PLOWS

THE PROMOUNT LINEUP WAS CREATED FOR BOTH PROFESSIONAL OPERATORS AND ENTHUSIASTS LOOKING TO TAKE THEIR TOOL KIT TO THE NEXT LEVEL. DESIGNED TO WORK AS EFFICIENTLY AS POSSIBLE, CAN-AM REIMAGINED THE PLOW FROM MOUNT TO BLADE.



MOST EFFICIENT MOUNTING SYSTEM



Underbelly mounting plate provides the optimal angle of attack for best push strength.

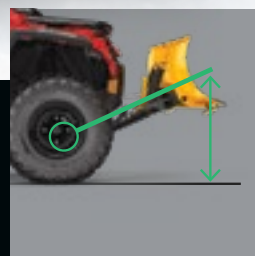

The forward mounted push frame provides industry leading lift height.



Low profile mounting plate has little impact on ground clearance and can be left installed year round.

CONNECTS WITH A CLICK

Attachable in **FOUR EASY STEPS**, the Can-Am ProMount plow system is the fastest, easiest way to start plowing and get the job done—minimal effort for maximum result.

1

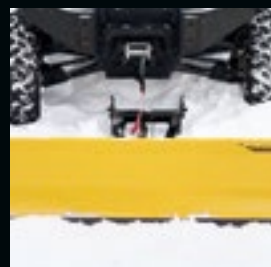

Drive straight toward the plow.

2

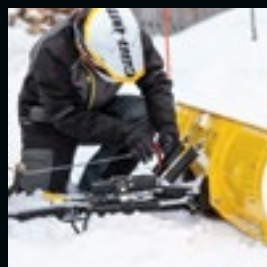

Attach the winch cable to the plow using a guiding hook/roller.

3

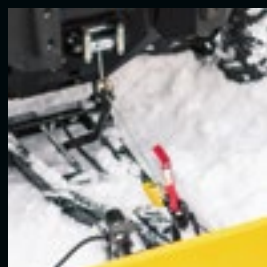

Lift the plow until it clips onto the mounting plate.

4

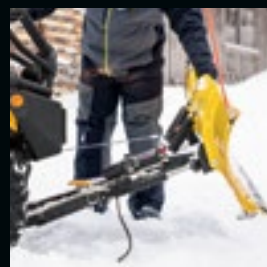

Remove the winch cable from the guide. You're ready to plow.

CAN-AM PROMOUNT ANGLE PLOWS

NEW CAN-AM ANGLE BLADES

- Make the job easier with the right tools, clear long alleys and make the task easier by sending the snow further out of the way.
- Wing end of plow measures 25" (63 cm) high and tapers down to 16" (41 cm).
- One-way "winged" state plow designed to throw snow higher.
- Rubber flap designed to keep snow away from the driver.
- Can-Am branded.

72" (183 CM) STEEL ONEWAY STATE BLADE 1915 zł
 ■ 715007264 · Black



YOUR JOB, YOUR CHOICE

Get a custom solution that truly fits the task at hand—with quality components and no cut corners. The ProMount mounting plate, push frame, and blades are a universal system that can be adapted to your specific Can-Am and jobsite.

CAN-AM PROMOUNT PUSH FRAME WITH QUICK-ATTACH SYSTEM

- Heavy-duty steel tubes designed to withstand the roughest use.
- Mid-mount carriage provides ultimate push strength and traction.
- Designed for maximum plow lift height.
- Features a self-aligning quick-attach system, an easy foot release pedal and an ergonomic handle for plow angle adjustment.
- Plow Roller Fairlead and Plow Limit Switch recommended to extend winch cable lifespan.
- Can-Am ProMount Mounting Plate required for installation.
- Blade swivels left or right, 5 positions.
- Large pin designed for easy blade rotation to eliminate dirt and snow buildup at pivot point.

Maverick, Maverick MAX 2515 zł
 715003910



PUSH FRAME EXTENSION

- 12" (30 cm) push frame extension required when plow is installed with Apache Track Systems.

Maverick, Maverick MAX 687 zł
 715006257



CAN-AM PROMOUNT MOUNTING PLATE

- Required to install the Can-Am ProMount Push Frame with Quick-Attach System.
- Mounting plate precision-designed to stay on year round without compromising ground clearance.
- Not compatible with S3 Front High Clearance A-Arm (715003784 and 715005116).

Maverick, Maverick MAX 619 zł
 715004484



CREATE YOUR OWN KIT

by choosing any plow type/length that you'd like for your push frame. **ProMount Push Frames are compatible with all the blades.**

CONSULT YOUR DEALER FOR THE BEST PLOW WIDTH. Made from 12-gauge steel and designed for efficient plowing, the ProMount steel blades are offered in multiple sizes to fit jobs large or small.

Some products shown may not be available or homologated in your country. Contact your BRP dealer for local details.

CAN-AM PROMOUNT FLEX2 PLOWS

Quady Śrem - tel. 61 28 35 657 - email: biuro@sklepatv.pl - www.sklepatv.pl

HMWPE (High Molecular Weight Polyethylene) technology gives Flex2 greater reliability, resistance to impact, and immunity to rust or deformation. Tough on jobs but flexible in the face of obstacles, the Flex2 blade simplifies work.

CAN-AM PROMOUNT FLEX2 PLOW KIT

These kits include:

- Can-Am ProMount Flex2 Blade
- Push Frame with Quick-Attach System
- Mounting Plate (not illustrated)

72" (183 CM) BLADE

Maverick, Maverick MAX

- 715006301 · Black

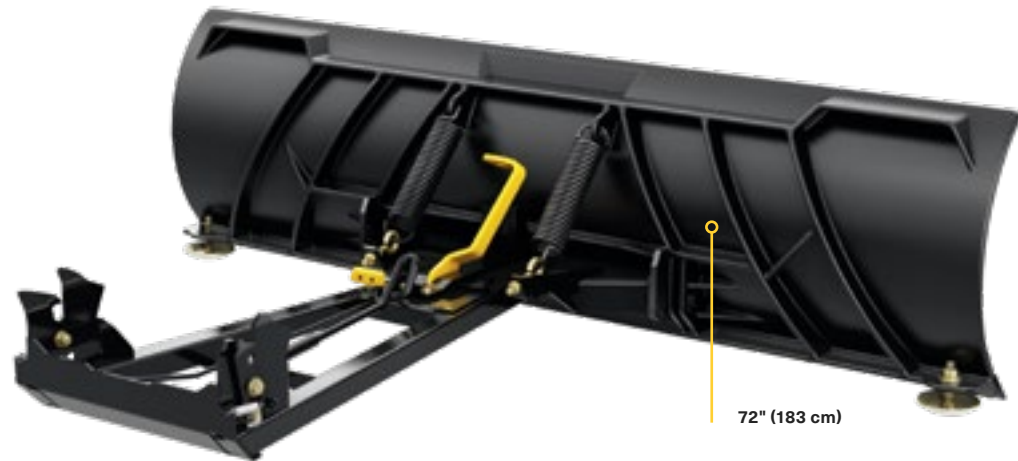

CAN-AM PROMOUNT FLEX2 BLADES

- Blades available individually to create your own kit.
- Compatible with Can-Am ProMount Blade accessories to further enhance plow versatility.

72" (183 CM) BLADE

- Clears 66" (168 cm) when plow is fully angled.

ProMount Push Frame 2305 zł

- 715004485 · Black



CONSULT YOUR DEALER FOR THE BEST PLOW WIDTH.

Made from 12-gauge steel and designed for efficient plowing, the ProMount steel blades are offered in multiple sizes to fit jobs large or small.

CREATE YOUR OWN KIT

by choosing any plow type/length that you'd like for your push frame. **ProMont Push Frames are compatible with all the blades.**

CAN-AM PROMOUNT STEEL PLOWS

Made from 12-gauge steel and designed for efficient plowing, the ProMount steel blades are offered in multiple sizes.

CAN-AM PROMOUNT STEEL PLOW KITS

These kits include:

- Can-Am ProMount Steel Blade
- Push Frame with Quick-Attach System
- Mounting Plate (not illustrated)

Maverick, Maverick MAX

- 715006302 · Black
- 715006303 · Yellow



CAN-AM PROMOUNT STEEL BLADES

- Blades available individually to create your own kit.
- Compatible with Can-Am ProMount Blade accessories to further enhance plow versatility.

72" (183 CM) BLADE

- Clears 66" (168 cm) when plow is fully angled.
- Blade height of 17" (43 cm).

ProMount Push Frame

- 715004474 · Black **1806 zł**
- 715006021 · Yellow



CONSULT YOUR DEALER FOR THE BEST PLOW WIDTH.

Made from 12-gauge steel and designed for efficient plowing, the ProMount steel blades are offered in multiple sizes to fit jobs large or small.

CREATE YOUR OWN KIT

by choosing any plow type/length that you'd like for your push frame. **ProMont Push Frames are compatible with all the blades.**

CAN-AM PROMOUNT PLOW ACCESSORIES

1 CAN-AM PROMOUNT EDGE MARKERS

- Help locate the edges of your plow.
- Height: 24" (60 cm).
- Sold in pairs.
- Compatible with Can-Am ProMount Steel and Flex2 Blades with or without Blade Extensions (except for the Can-Am ProMount Steel 54" (137 cm) Blades).

Maverick, Maverick MAX 203 zł
715004206



2 CAN-AM PROMOUNT PLASTIC WEAR BLADE*

- To help prevent scratches on smooth driveways and markable surfaces.

Maverick, Maverick MAX
66" (168 cm) 72" (183 cm)
715004482 715004483
369 zł 619 zł

3 CAN-AM PROMOUNT DRIFT CUTTERS*

- Help keep snow in the plow.
- Dimensions: 17" x 13" (43.2 cm x 33 cm).
- Sold in pairs.
- Compatible with Can-Am ProMount Steel and Flex2 Blades with or without Blade Extensions (except for the Can-Am ProMount Steel 54" [137 cm] Blades).

Maverick, Maverick MAX 619 zł
715006258

4 CAN-AM PROMOUNT BLADE EXTENSIONS

- Add 3" (8 cm) each side.
- Compatible with Can-Am ProMount Blades (except for Can-Am ProMount Steel 54" [137 cm] Blade).
- Longer Wear Blade can be installed to further extend the extra length already provided by the extensions.
- Compatible with Can-Am ProMount Steel and Flex2 Blades (except for the Can-Am ProMount Steel 54" [137 cm] Blades).

Maverick, Maverick MAX
715004205 • Black 458 zł
715005319 • Yellow



PLOW ANGLING SYSTEM

- Converts your plow system into an easy-to-control unit from the driver's seat.
- Allows you to have full up/down and left/right plow control at your fingertips by using the supplied joystick.
- Using one hand to control all plow motions will allow you to easily concentrate and manage your plowing tasks.
- Not compatible with Backcountry LT track kits on Maverick.

Compatible with any ProMount Push Frame and Blade
715006022 5162 zł

PLOW ROLLER FAIRLEAD

- Larger diameter lower roller reduces wear on wire rope for plow application.
- Can be used with all ProMount plows.

Maverick, Maverick MAX 318 zł
705203753



PLOW LIMIT SWITCH

- (Not illustrated)
- For controlling the cable tension when over raising your plow system.
- Prevents winch, plow push frame and vehicle damage.
- Sensor relocated for optimal lift height.

Maverick, Maverick MAX 590 zł
715006259



TIRES

X DS TIRE MAXXIS BIGHORN

(Not illustrated)
Front - 29" x 9" x 14"
705402081 832 zł

Rear - 29" x 11" x 14"
705502604 872 zł

X RS TIRE MAXXIS BIGHORN

(Not illustrated)
Front & Rear - 30" x 10" x 14"
705402082 942 zł

MAXXIS BIGHORN 2.0 TIRE

Front - 28" x 9" x 14"
705402080 762 zł

Rear - 28" x 11" x 14"
705502603 742 zł

Front - 27" x 9" x 14"
705402168 (C) 722 zł

Rear - 27" x 11" x 14"
705502665 (C) 722 zł



MAXXIS LIBERTY TIRE

- Engineered for performance driving and to give you and your side-by-side freedom in a variety of terrains.
- 8-ply radial construction.

Maverick Xrc
30" x 10" x 14"
705402143 892 zł

32" x 10" x 15"
705402464

992 zł



RIMS

14" MAVERICK X RC RIM

- Black with clear coat aluminum rim.

Maverick, Maverick MAX
705402256 960 zł



14" MAVERICK BEADLOCK RIM

- Black aluminum rim with machined face and clear coat.
- Choice of beadlock color (not included).
- Needs 16 bolts (250000893) for installing the beadlock.

Maverick, Maverick MAX
705402207 • Black and machined
705402173 • Black 960 zł



14" MAVERICK BEADLOCK RIM

- Black with clear coat aluminum rim.
- Choice of beadlock color.
- Needs 16 bolts (250000893) for installing the beadlock.

Maverick, Maverick MAX
Front - 14" x 7"
Offset = 55 mm
• For Xrs = Front and rear
705402393 966 zł

Rear - 14" x 8"
Offset = 76mm
705502814

1018 zł



14" MAVERICK RIM

- Black with clear coat aluminum rim.

Maverick & Maverick MAX
Front - 14" x 7"
• Offset = 55 mm
705401965 388 zł

Rear - 14" x 8"
• Offset = 76 mm
705502493

555 zł



14" MAVERICK BEADLOCK RING

- Cast aluminum beadlock.
- Must be installed on Front Rim (705401706) and Rear Rim (705502286).

Maverick & Maverick MAX
(Xrs, Xds models only)
705401709 • Black 411 zł
705401913 • Gold 411 zł
705402358 • Can-Am Red 376 zł
705402472 • Manta Green 411 zł



EXPLORE AN ENTIRE WORLD OF ADVENTURE WITH ALL OF OUR BRP PRODUCTS. BRP.COM

APPAREL

Clothing, helmets, glasses and everything else you need to shift your Can-Am experience into high gear.

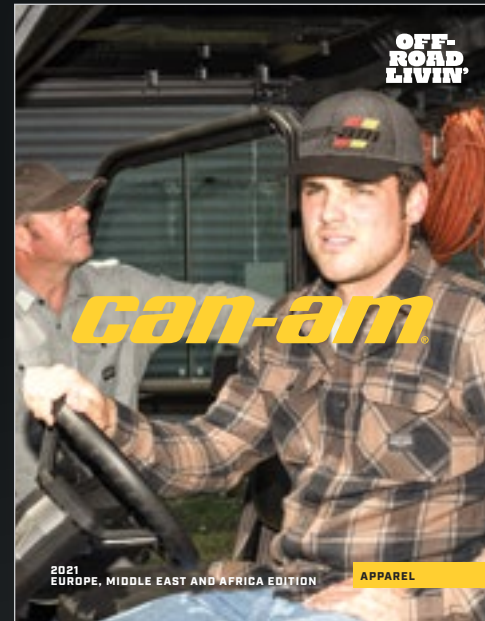

PARTS & MAINTENANCE

Essential items to keep your Can-Am tearing up the tarmac, including oils, filters maintenance products and cleaning products.



ski-doo LYNX SEA-DOO can-am ROTAX ALUMAcraft Manitou EVIRUDE

